

2026

Switzerland

**LIVING  
THE  
LIGHT®**

serien  
.lighting



<b>ANNEX</b>	Ceiling	2
	Suspension	5
<b>APP</b>	Wall	7
<b>CAVITY</b>	Ceiling	8
	Recessed	11
	Suspension	14
	Wall	16
<b>CLUB</b>	Floor	18
	Wall	19
<b>CRIB</b>	Wall	20
<b>CURLING</b>	Ceiling	21
	Suspension	26
	Wall	30
<b>DON</b>	Ceiling <small>new</small>	34
	Suspension <small>new</small>	37
	Wall <small>new</small>	40
<b>DRAFT</b>	Ceiling	42
	Suspension	45
<b>DRUM</b>	Ceiling	47
	Suspension	49
<b>JOB</b>	Table	51
<b>JONES</b>	Floor	52
<b>LYD</b>	Wall	53
<b>ONE EIGHTY</b>	Suspension	54
<b>POPPY</b>	Ceiling	55
	Suspension	57
	Table	58
	Floor	59
<b>REEF</b>	Ceiling	60
	Suspension	60
	Wall	61
<b>REFLEX<sup>2</sup></b>	Ceiling <small>new</small>	62
	Wall	73
	Table	73
	Floor	74
<b>ROD</b>	Wall	75
<b>SLICE<sup>2</sup></b>	Furniture	76
	Floor	78
<b>SLICE<sup>2</sup> PI</b>	Ceiling <small>new</small>	79
	Suspension <small>new</small>	84
	Wall <small>new</small>	94
<b>SML</b>	Wall	97
<b>SML<sup>2</sup></b>	Wall 150 - 300	99
	Wall 600 - 1200	102
<b>TWIN</b>	Suspension	105
<b>ZOOM</b>	Suspension	106

Info	Product information	108
	Luminaire features	109
	Lighting technology	110
	Contacts	111
	Awards	112
	Imprint	

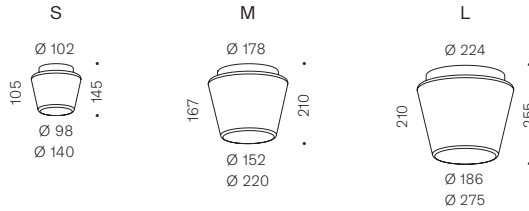
# ANNEX Ceiling





## ANNEX Ceiling S new





Abbildung figure	Beschreibung description	Leuchtmittel lamp	Regelung control	Leistung power	CCT	EEK EEC	Lumen lumen	Art.-Nr. art.-no.	€ netto CH excl. VAT		
	Reflektor opal reflector opal	LED	TRIAC	9 W	2700 K	F	950lm	AN3201	384,70 €		
					3000 K	E	1000lm	AN3202			
					4000 K <span style="color: blue;">new</span>	E	1030lm	AN3208			
			DALI <span style="color: blue;">new</span>	9 W	2700 K	F	950lm	AN3206		412,18 €	
					3000 K	E	1000lm	AN3207			
					4000 K	E	1030lm	AN3209			
		CASAMBI <span style="color: blue;">new</span>	9 W	2700 K	F	950lm	AN3201C	471,72 €			
				3000 K	E	1000lm	AN3202C				
				4000 K	E	1030lm	AN3208C				
		G9	TRIAC	max. 60 W			G	980lm	AN1013	297,69 €	
			Reflektor poliert reflector polished	LED	TRIAC	9 W	2700 K	F	950lm	AN3211	412,18 €
							3000 K	E	1000lm	AN3212	
4000 K <span style="color: blue;">new</span>	E						1030lm	AN3213			
DALI <span style="color: blue;">new</span>	9 W				2700 K	F	950lm	AN3216	439,66 €		
					3000 K	E	1000lm	AN3217			
					4000 K	E	1030lm	AN3218			
CASAMBI <span style="color: blue;">new</span>	9 W			2700 K	F	950lm	AN3211C	503,78 €			
				3000 K	E	1000lm	AN3212C				
				4000 K	E	1030lm	AN3213C				
G9	TRIAC			max. 60 W			G	980lm	AN1121	320,59 €	
	Reflektor Kristall reflector crystal			LED	TRIAC	9 W	2700 K	F	950lm	AN3221	490,04 €
							3000 K	E	1000lm	AN3222	
		4000 K <span style="color: blue;">new</span>	E				1030lm	AN3223			
		DALI <span style="color: blue;">new</span>	9 W		2700 K	F	950lm	AN3226	517,52 €		
					3000 K	E	1000lm	AN3227			
					4000 K	E	1030lm	AN3228			
		CASAMBI <span style="color: blue;">new</span>	9 W	2700 K	F	950lm	AN3221C	577,06 €			
				3000 K	E	1000lm	AN3222C				
				4000 K	E	1030lm	AN3223C				
		G9	TRIAC	max. 60 W			G	980lm	AN1043	403,03 €	

IP20     
protection class lamp included individual

LED     
dimmable CRI >97 SDCM 2



# ANNEX Ceiling M new

Abbildung figure	Beschreibung description	Leuchtmittel lamp	Regelung control	Leistung power	CCT	EEL EEC	Lumen lumen	Art.-Nr. art.-no.	€ netto CH excl. VAT			
	Reflektor opal reflector opal	LED	DALI	27 W	2700K	F	1910lm	AN3001	522,10 €			
					3000K	E	2010lm	AN3002				
					4000K <span style="color: #0070C0;">new</span>	E	2080lm	AN3009				
			CASAMBI <span style="color: #0070C0;">new</span>	20 W	2700K	F	1910lm	AN3006		613,70 €		
					3000K	F	2750lm	AN3007				
					4000K <span style="color: #0070C0;">new</span>	E	2910lm	AN3008				
		B15d	TRIAC	max. 100W		G	1800lm	AN1066	384,70 €			
			Reflektor poliert reflector polished	LED	DALI	27 W	2700K	F	1910lm	AN3011	558,74 €	
							3000K	E	2010lm	AN3012		
							4000K <span style="color: #0070C0;">new</span>	E	2080lm	AN3018		
					CASAMBI <span style="color: #0070C0;">new</span>	20 W	2700K	F	1910lm	AN3015		650,34 €
							3000K	F	2750lm	AN3016		
4000K <span style="color: #0070C0;">new</span>	E						2910lm	AN3017				
B15d	TRIAC			max. 100W		G	1800lm	AN1078	421,34 €			
	Reflektor Kristall reflector crystal			LED	DALI	27 W	2700K	F	1910lm	AN3021	677,82 €	
							3000K	E	2010lm	AN3022		
							4000K <span style="color: #0070C0;">new</span>	E	2080lm	AN3028		
					CASAMBI <span style="color: #0070C0;">new</span>	20 W	2700K	F	1910lm	AN3025		769,41 €
							3000K	F	2750lm	AN3026		
		4000K <span style="color: #0070C0;">new</span>	E				2910lm	AN3027				
		B15d	TRIAC	max. 100W		G	1800lm	AN1073	540,42 €			

 IP20 protection class  
 through wiring  
 emergency light option  
 individual

 LED  
 dimmable  
 CRI >97  
 SDCM 2

# ANNEX Ceiling L new

Abbildung figure	Beschreibung description	Leuchtmittel lamp	Regelung control	Leistung power	CCT	EEK EEC	Lumen lumen	Art.-Nr. art.-no.	€ netto CH excl. VAT	
	Reflektor opal reflector opal	LED	TRIAC	34 W	2700 K	F	3510lm	AN3047	604,54 €	
					3000 K	E	3710lm	AN3048		
					4000 K <span style="color: #0070C0;">new</span>	E	3830lm	AN3093		
			DALI	41 W	2700 K	F	4060lm	AN3051		650,34 €
					3000 K	E	4270lm	AN3052		
					4000 K <span style="color: #0070C0;">new</span>	E	4410lm	AN3094		
			CASAMBI <span style="color: #0070C0;">new</span>	34 W	2700 K	F	3510lm	AN3047C		691,55 €
					3000 K	E	3710lm	AN3048C		
					4000 K	E	3830lm	AN3093C		
	Reflektor poliert reflector polished	LED	TRIAC	34 W	2700 K	F	3510lm	AN3053	650,34 €	
					3000 K	E	3710lm	AN3054		
					4000 K <span style="color: #0070C0;">new</span>	E	3830lm	AN3095		
			DALI	41 W	2700 K	F	4060lm	AN3057		696,14 €
					3000 K	E	4270lm	AN3058		
					4000 K <span style="color: #0070C0;">new</span>	E	4410lm	AN3096		
			CASAMBI <span style="color: #0070C0;">new</span>	34 W	2700 K	F	3510lm	AN3053C		741,93 €
					3000 K	E	3710lm	AN3054C		
					4000 K	E	3830lm	AN3095C		
	Reflektor Kristall reflector crystal	LED	TRIAC	34 W	2700 K	F	3510lm	AN3041	828,95 €	
					3000 K	E	3710lm	AN3042		
					4000 K <span style="color: #0070C0;">new</span>	E	3830lm	AN3097		
			DALI	41 W	2700 K	F	4060lm	AN3045		879,32 €
					3000 K	E	4270lm	AN3046		
					4000 K <span style="color: #0070C0;">new</span>	E	4410lm	AN3098		
			CASAMBI <span style="color: #0070C0;">new</span>	34 W	2700 K	F	3510lm	AN3041C		920,55 €
					3000 K	E	3710lm	AN3042C		
					4000 K	E	3830lm	AN3097C		



 IP20 protection class  
 through wiring  
 emergency light option  
 battery option  
 individual

 LED  
 dimmable  
 Zhaga standard  
 CRI >97  
 SDCM 2

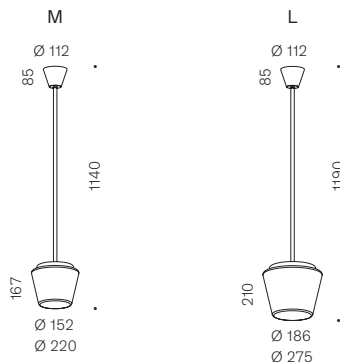
# ANNEX Suspension





## ANNEX Suspension M new

Abbildung figure	Beschreibung description	Regelung control	Leistung power	CCT	EEL EEC	Lumen	Art.-Nr. art.-no.	€ netto CH excl. VAT
	Reflektor opal reflector opal	TRIAC	20 W	2700K	F	1910lm	AN3101	691,55 €
				3000K	E	2010lm	AN3102	
				4000K <span style="background-color: #0070C0; color: white; padding: 2px;">new</span>	E	2080lm	AN3187	
		DALI	27 W	2700K	F	2900lm	AN3105	732,77 €
				3000K	F	2750lm	AN3106	
				4000K <span style="background-color: #0070C0; color: white; padding: 2px;">new</span>	E	2910lm	AN3188	
CASAMBI <span style="background-color: #0070C0; color: white; padding: 2px;">new</span>	20 W	2700K	F	1910lm	AN3101C	783,15 €		
		3000K	E	2010lm	AN3102C			
		4000K	E	2080lm	AN3187C			
	Reflektor poliert reflector polished	TRIAC	20 W	2700K	F	1910lm	AN3111	732,77 €
				3000K	E	2010lm	AN3112	
				4000K <span style="background-color: #0070C0; color: white; padding: 2px;">new</span>	E	2080lm	AN3189	
		DALI	27 W	2700K	F	2900lm	AN3116	769,41 €
				3000K	F	2750lm	AN3117	
				4000K <span style="background-color: #0070C0; color: white; padding: 2px;">new</span>	E	2910lm	AN3190	
CASAMBI <span style="background-color: #0070C0; color: white; padding: 2px;">new</span>	20 W	2700K	F	1910lm	AN3111C	819,79 €		
		3000K	E	2010lm	AN3112C			
		4000K	E	2080lm	AN3189C			
	Reflektor Kristall reflector crystal	TRIAC	20 W	2700K	F	1910lm	AN3121	851,85 €
				3000K	E	2010lm	AN3122	
				4000K <span style="background-color: #0070C0; color: white; padding: 2px;">new</span>	E	2080lm	AN3191	
		DALI	27 W	2700K	F	2900lm	AN3125	888,49 €
				3000K	F	2750lm	AN3126	
				4000K <span style="background-color: #0070C0; color: white; padding: 2px;">new</span>	E	2910lm	AN3192	
CASAMBI <span style="background-color: #0070C0; color: white; padding: 2px;">new</span>	20 W	2700K	F	1910lm	AN3121C	938,86 €		
		3000K	E	2010lm	AN3122C			
		4000K	E	2080lm	AN3191C			

IP20  
 protection class

 through wiring

 tube cuttable

 + length option

 emergency light option

 individual



LED

 dimmable

 CRI >97

 SDCM 3

# ANNEX Suspension L new

Abbildung figure	Beschreibung description	Regelung control	Leistung power	CCT	EEL EEC	Lumen lumen	Art.-Nr. art.-no.	€ netto CH excl. VAT
	<b>Reflektor opal</b> reflector opal	TRIAC	34 W	2700 K	F	3510lm	AN3147	773,99 €
				3000 K	E	3710lm	AN3148	
				4000 K <span style="color: #0070C0;">new</span>	E	3830lm	AN3193	
		DALI	41 W	2700 K	F	4060lm	AN3151	819,79 €
				3000 K	E	4270lm	AN3152	
				4000 K <span style="color: #0070C0;">new</span>	E	4410lm	AN3194	
		CASAMBI <span style="color: #0070C0;">new</span>	34 W	2700 K	F	3510lm	AN3147C	865,59 €
				3000 K	E	3710lm	AN3148C	
				4000 K	E	3830lm	AN3193C	
	<b>Reflektor poliert</b> reflector polished	TRIAC	34 W	2700 K	F	3510lm	AN3153	819,79 €
				3000 K	E	3710lm	AN3154	
				4000 K <span style="color: #0070C0;">new</span>	E	3830lm	AN3195	
		DALI	41 W	2700 K	F	4060lm	AN3157	870,17 €
				3000 K	E	4270lm	AN3158	
				4000 K <span style="color: #0070C0;">new</span>	E	4410lm	AN3196	
		CASAMBI <span style="color: #0070C0;">new</span>	34 W	2700 K	F	3510lm	AN3153C	911,38 €
				3000 K	E	3710lm	AN3154C	
				4000 K	E	3830lm	AN3195C	
	<b>Reflektor Kristall</b> reflector crystal	TRIAC	34 W	2700 K	F	3510lm	AN3141	1.002,99 €
				3000 K	E	3710lm	AN3142	
				4000 K <span style="color: #0070C0;">new</span>	E	3830lm	AN3197	
		DALI	41 W	2700 K	F	4060lm	AN3145	1.048,78 €
				3000 K	E	4270lm	AN3146	
				4000 K <span style="color: #0070C0;">new</span>	E	4410lm	AN3198	
		CASAMBI <span style="color: #0070C0;">new</span>	34 W	2700 K	F	3510lm	AN3141C	1.094,58 €
				3000 K	E	3710lm	AN3142C	
				4000 K	E	3830lm	AN3197C	

-  IP20  
protection class
-  through wiring
-  tube cuttable
-  + length option
-  emergency light option
-  battery option
-  individual

-  LED
-  dimmable
-  Zhaga standard
-  CRI >97
-  SDCM 3

# APP Wall

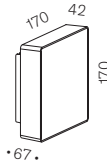

## APP Wall

Abbildung figure	Beschreibung description	Regelung control	Leistung power	CCT	EEK EEC	Lumen lumen	Art.-Nr. art.-no.	€ netto CH excl. VAT
	<b>Leuchteneinheit APP</b> lighting unit APP	TRIAC	16 W	2700 K	E	1930 lm	AP1001	320,59 €
				3000 K	E	1970 lm	AP1002	
		DALI	22 W	2700 K	E	2750 lm	AP1005	366,38 €
				3000 K	E	2810 lm	AP1006	
	<b>Front Rippe</b> front ribbed						AP1101	
	<b>Front Pyramide</b> front pyramid						AP1102	
	<b>Front Wabe</b> front honeycomb						AP1103	
	<b>Front Eiskristall</b> front cracked ice						AP1104	91,59 €
	<b>Front Weiß</b> front white						AP1105	
	<b>Front Grau</b> front grey						AP1107	
	<b>Front fluoreszierend Grün</b> front fluorescent green						AP1108	
	<b>Front Echtglasspiegel</b> front genuine glass mirror						AP1106	114,49 €
	modular article		IP40 protection class		through wiring		individual	
							LED	
							dimmable	
							CRI > 90	
							SDCM 3	

## Zubehör/Accessories

Abbildung figure	Beschreibung description	Art.-Nr. art.-no.	€ netto CH excl. VAT
	<b>Spiegeladapter Set</b> mirror adapter set	ZB1001	41,22 €

# CAVITY Ceiling

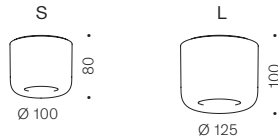

## CAVITY Ceiling S Linse 46° new

Abbildung figure	Beschreibung description	Regelung control	Leistung power	CCT	EEK EEC	Lumen lumen	Art.-Nr. art.-no.	€ netto CH excl. VAT
●	schwarz black	TRIAC	10W	2700K	E	950lm	CA1001L	233,58 €
				3000K	E	1000lm	CA1002L	
		DALI <span style="color: blue; font-weight: bold;">new</span>	10W	2700K	E	950lm	CA1011L	283,95 €
				3000K	E	1000lm	CA1012L	
		CASAMBI <span style="color: blue; font-weight: bold;">new</span>	10W	2700K	E	950lm	CA1011LC	320,59 €
				3000K	E	1000lm	CA1012LC	
○	weiß white	TRIAC	10W	2700K	E	950lm	CA1003L	233,58 €
				3000K	E	1000lm	CA1004L	
		DALI <span style="color: blue; font-weight: bold;">new</span>	10W	2700K	E	950lm	CA1013L	283,95 €
				3000K	E	1000lm	CA1014L	
		CASAMBI <span style="color: blue; font-weight: bold;">new</span>	10W	2700K	E	950lm	CA1013LC	320,59 €
				3000K	E	1000lm	CA1014LC	
●	Aluminiumglanz finish aluminum gloss finish	TRIAC	10W	2700K	E	950lm	CA1005L	270,21 €
				3000K	E	1000lm	CA1006L	
		DALI <span style="color: blue; font-weight: bold;">new</span>	10W	2700K	E	950lm	CA1015L	306,85 €
				3000K	E	1000lm	CA1016L	
		CASAMBI <span style="color: blue; font-weight: bold;">new</span>	10W	2700K	E	950lm	CA1005LC	352,65 €
				3000K	E	1000lm	CA1006LC	
●	Bronze finish bronze finish	TRIAC	10W	2700K	E	950lm	CA1007L	270,21 €
				3000K	E	1000lm	CA1008L	
		DALI <span style="color: blue; font-weight: bold;">new</span>	10W	2700K	E	950lm	CA1017L	306,85 €
				3000K	E	1000lm	CA1018L	
		CASAMBI <span style="color: blue; font-weight: bold;">new</span>	10W	2700K	E	950lm	CA1007LC	352,65 €
				3000K	E	1000lm	CA1008LC	

IP40  
protection  
class

glass  
lens

individual

LED

dimmable

Zhaga  
standard

CRI >97

SDCM 2

## CAVITY Ceiling S new

Abbildung figure	Beschreibung description	Regelung control	Leistung power	CCT	EEL EEC	Lumen lumen	Art.-Nr. art.-no.	€ netto CH excl. VAT
●	schwarz black	TRIAC	10 W	2700 K	F	950 lm	CA1001	210,68 €
				3000 K	E	1000 lm	CA1002	
		DALI <span style="color: blue;">new</span>	10 W	2700 K	F	950 lm	CA1011	261,06 €
				3000 K	E	1000 lm	CA1012	
		CASAMBI <span style="color: blue;">new</span>	10 W	2700 K	F	950 lm	CA1011C	311,42 €
				3000 K	E	1000 lm	CA1012C	
○	weiß white	TRIAC	10 W	2700 K	F	950 lm	CA1003	210,68 €
				3000 K	E	1000 lm	CA1004	
		DALI <span style="color: blue;">new</span>	10 W	2700 K	F	950 lm	CA1013	261,06 €
				3000 K	E	1000 lm	CA1014	
		CASAMBI <span style="color: blue;">new</span>	10 W	2700 K	F	950 lm	CA1013C	311,42 €
				3000 K	E	1000 lm	CA1014C	
●	Aluminiumglanz finish aluminum gloss finish	TRIAC	10 W	2700 K	F	950 lm	CA1005	247,31 €
				3000 K	E	1000 lm	CA1006	
		DALI <span style="color: blue;">new</span>	10 W	2700 K	F	950 lm	CA1015	283,95 €
				3000 K	E	1000 lm	CA1016	
		CASAMBI <span style="color: blue;">new</span>	10 W	2700 K	F	950 lm	CA1015C	348,07 €
				3000 K	E	1000 lm	CA1016C	
●	Bronze finish bronze finish	TRIAC	10 W	2700 K	F	950 lm	CA1007	247,31 €
				3000 K	E	1000 lm	CA1008	
		DALI <span style="color: blue;">new</span>	10 W	2700 K	F	950 lm	CA1017	283,95 €
				3000 K	E	1000 lm	CA1018	
		CASAMBI <span style="color: blue;">new</span>	10 W	2700 K	F	950 lm	CA1017C	352,65 €
				3000 K	E	1000 lm	CA1018C	

IP40  
protection  
class

 glass  
diffusor

 individual

LED

 dimmable

 Zhaga  
standard

 CRI >97

 SDCM 2

## CAVITY Ceiling L Linse 60° new

Abbildung figure	Beschreibung description	Regelung control	Leistung power	CCT	EEL EEC	Lumen lumen	Art.-Nr. art.-no.	€ netto CH excl. VAT
●	schwarz black	TRIAC	20 W	2700 K	E	1910 lm	CA2001L	297,69 €
				3000 K	E	2010 lm	CA2002L	
		DALI	20 W	2700 K	E	1910 lm	CA2005L	352,65 €
				3000 K	E	2010 lm	CA2006L	
		CASAMBI <span style="color: blue;">new</span>	20 W	2700 K	E	1910 lm	CA2005LC	384,70 €
				3000 K	E	2010 lm	CA2006LC	
○	weiß white	TRIAC	20 W	2700 K	E	1910 lm	CA2007L	297,69 €
				3000 K	E	2010 lm	CA2008L	
		DALI	20 W	2700 K	E	1910 lm	CA2011L	352,65 €
				3000 K	E	2010 lm	CA2012L	
		CASAMBI <span style="color: blue;">new</span>	20 W	2700 K	E	1910 lm	CA2011LC	384,70 €
				3000 K	E	2010 lm	CA2012LC	
●	Aluminiumglanz finish aluminum gloss finish	TRIAC	20 W	2700 K	E	1910 lm	CA2013L	338,90 €
				3000 K	E	2010 lm	CA2014L	
		DALI	20 W	2700 K	E	1910 lm	CA2017L	398,45 €
				3000 K	E	2010 lm	CA2018L	
		CASAMBI <span style="color: blue;">new</span>	20 W	2700 K	E	1910 lm	CA2017LC	425,93 €
				3000 K	E	2010 lm	CA2018LC	

Abbildung figure	Beschreibung description	Regelung control	Leistung power	CCT	EEL EEC	Lumen lumen	Art.-Nr. art.-no.	€ netto CH excl. VAT	
●	<b>Bronze finish</b> bronze finish	TRIAC	20W	2700K	E	1910lm	CA2019L	338,90 €	
				3000K	E	2010lm	CA2020L		
		DALI	20W	2700K	E	1910lm	CA2023L		398,45 €
				3000K	E	2010lm	CA2024L		
		CASAMBI <small>new</small>	20W	2700K	E	1910lm	CA2023LC		425,93 €
				3000K	E	2010lm	CA2024LC		

IP40 protection class  
 through wiring  
 glass lens  
 emergency light option  
 individual

LED  
 dimmable  
 Zhaga standard  
 CRI >97  
 SDCM 2

## CAVITY Ceiling L new

Abbildung figure	Beschreibung description	Regelung control	Leistung power	CCT	EEL EEC	Lumen lumen	Art.-Nr. art.-no.	€ netto CH excl. VAT
●	<b>schwarz</b> black	TRIAC	20W	2700K	F	1910lm	CA2001	274,79 €
				3000K	E	2010lm	CA2002	
		DALI	20W	2700K	F	1910lm	CA2005	329,75 €
				3000K	E	2010lm	CA2006	
		CASAMBI <small>new</small>	20W	2700K	F	1910lm	CA2005C	384,70 €
				3000K	E	2010lm	CA2006C	
○	<b>weiß</b> white	TRIAC	20W	2700K	F	1910lm	CA2007	274,79 €
				3000K	E	2010lm	CA2008	
		DALI	20W	2700K	F	1910lm	CA2011	329,75 €
				3000K	E	2010lm	CA2012	
		CASAMBI <small>new</small>	20W	2700K	F	1910lm	CA2011C	384,70 €
				3000K	E	2010lm	CA2012C	
●	<b>Aluminiumglanz finish</b> aluminum gloss finish	TRIAC	20W	2700K	F	1910lm	CA2013	316,01 €
				3000K	E	2010lm	CA2014	
		DALI	20W	2700K	F	1910lm	CA2017	375,55 €
				3000K	E	2010lm	CA2018	
		CASAMBI <small>new</small>	20W	2700K	F	1910lm	CA2017C	425,93 €
				3000K	E	2010lm	CA2018C	
●	<b>Bronze finish</b> bronze finish	TRIAC	20W	2700K	F	1910lm	CA2019	316,01 €
				3000K	E	2010lm	CA2020	
		DALI	20W	2700K	F	1910lm	CA2023	375,55 €
				3000K	E	2010lm	CA2024	
		CASAMBI <small>new</small>	20W	2700K	F	1910lm	CA2023C	425,93 €
				3000K	E	2010lm	CA2024C	

IP40 protection class  
 through wiring  
 glass diffuser  
 emergency light option  
 individual

LED  
 dimmable  
 Zhaga standard  
 CRI >97  
 SDCM 2

# CAVITY Recessed

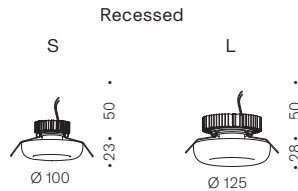

## CAVITY Recessed S Linse 46° new

Abbildung figure	Beschreibung description	Regelung control	Leistung power	CCT	EEK EEC	Lumen lumen	Art.-Nr. art.-no.	€ netto CH excl. VAT
●	schwarz black	TRIAC	12 W	2700K	E	1120lm	CA1301L	219,83 €
				3000K	E	1190lm	CA1302L	
		DALI <span style="color: blue;">new</span>	12 W	2700K	E	1120lm	CA1311L	261,06 €
				3000K	E	1190lm	CA1312L	
		CASAMBI <span style="color: blue;">new</span>	12 W	2700K	E	1120lm	CA1301LC	306,85 €
				3000K	E	1190lm	CA1302LC	
○	weiß white	TRIAC	12 W	2700K	E	1120lm	CA1303L	219,83 €
				3000K	E	1190lm	CA1304L	
		DALI <span style="color: blue;">new</span>	12 W	2700K	E	1120lm	CA1313L	261,06 €
				3000K	E	1190lm	CA1314L	
		CASAMBI <span style="color: blue;">new</span>	12 W	2700K	E	1120lm	CA1303LC	306,85 €
				3000K	E	1190lm	CA1304LC	
●	Aluminiumglanz finish aluminum gloss finish	TRIAC	12 W	2700K	E	1120lm	CA1305L	251,89 €
				3000K	E	1190lm	CA1306L	
		DALI <span style="color: blue;">new</span>	12 W	2700K	E	1120lm	CA1315L	288,53 €
				3000K	E	1190lm	CA1316L	
		CASAMBI <span style="color: blue;">new</span>	12 W	2700K	E	1120lm	CA1305LC	334,32 €
				3000K	E	1190lm	CA1306LC	
●	Bronze finish bronze finish	TRIAC	12 W	2700K	E	1120lm	CA1307L	251,89 €
				3000K	E	1190lm	CA1308L	
		DALI <span style="color: blue;">new</span>	12 W	2700K	E	1120lm	CA1317L	288,53 €
				3000K	E	1190lm	CA1318L	
		CASAMBI <span style="color: blue;">new</span>	12 W	2700K	E	1120lm	CA1307LC	334,32 €
				3000K	E	1190lm	CA1308LC	

IP40 protection class  
 through wiring  
 glass lens  
 cut 80mm  
 driver included  
 emergency light option  
 individual

LED LED  
 dimmable  
 Zhaga standard  
 CRI >97  
 SDCM 2

## CAVITY Recessed S new

Abbildung figure	Beschreibung description	Regelung control	Leistung power	CCT	EEL EEC	Lumen lumen	Art.-Nr. art.-no.	€ netto CH excl. VAT
●	schwarz black	TRIAC	12 W	2700 K	F	1120 lm	CA1301	196,93 €
				3000 K	E	1190 lm	CA1302	
		DALI <span style="color: #0070C0;">new</span>	12 W	2700 K	F	1120 lm	CA1311	233,58 €
				3000 K	E	1190 lm	CA1312	
		CASAMBI <span style="color: #0070C0;">new</span>	12 W	2700 K	F	1120 lm	CA1311C	283,95 €
				3000 K	E	1190 lm	CA1312C	
○	weiß white	TRIAC	12 W	2700 K	F	1120 lm	CA1303	196,93 €
				3000 K	E	1190 lm	CA1304	
		DALI <span style="color: #0070C0;">new</span>	12 W	2700 K	F	1120 lm	CA1313	233,58 €
				3000 K	E	1190 lm	CA1314	
		CASAMBI <span style="color: #0070C0;">new</span>	12 W	2700 K	F	1120 lm	CA1313C	283,95 €
				3000 K	E	1190 lm	CA1314C	
●	Aluminiumglanz finish aluminum gloss finish	TRIAC	12 W	2700 K	F	1120 lm	CA1305	224,41 €
				3000 K	E	1190 lm	CA1306	
		DALI <span style="color: #0070C0;">new</span>	12 W	2700 K	F	1120 lm	CA1315	265,63 €
				3000 K	E	1190 lm	CA1316	
		CASAMBI <span style="color: #0070C0;">new</span>	12 W	2700 K	F	1120 lm	CA1315C	311,42 €
				3000 K	E	1190 lm	CA1316C	
●	Bronze finish bronze finish	TRIAC	12 W	2700 K	F	1120 lm	CA1307	224,41 €
				3000 K	E	1190 lm	CA1308	
		DALI <span style="color: #0070C0;">new</span>	12 W	2700 K	F	1120 lm	CA1317	265,63 €
				3000 K	E	1190 lm	CA1318	
		CASAMBI <span style="color: #0070C0;">new</span>	12 W	2700 K	F	1120 lm	CA1317C	311,42 €
				3000 K	E	1190 lm	CA1318C	

 IP40 protection class  
 through wiring  
 glass diffuser  
 cut 80 mm  
 driver included  
 emergency light option  
 individual

 LED  
 dimmable  
 Zhaga standard  
 CRI >97  
 SDCM 2

## CAVITY Recessed L Linse 60° new

Abbildung figure	Beschreibung description	Regelung control	Leistung power	CCT	EEL EEC	Lumen lumen	Art.-Nr. art.-no.	€ netto CH excl. VAT
●	schwarz black	TRIAC	20 W	2700 K	E	1910 lm	CA2301L	283,95 €
				3000 K	E	2010 lm	CA2302L	
		DALI	20 W	2700 K	E	1910 lm	CA2305L	338,90 €
				3000 K	E	2010 lm	CA2306L	
		CASAMBI <span style="color: #0070C0;">new</span>	20 W	2700 K	E	1910 lm	CA2301LC	370,97 €
				3000 K	E	2010 lm	CA2302LC	
○	weiß white	TRIAC	20 W	2700 K	E	1910 lm	CA2307L	283,95 €
				3000 K	E	2010 lm	CA2308L	
		DALI	20 W	2700 K	E	1910 lm	CA2311L	338,90 €
				3000 K	E	2010 lm	CA2312L	
		CASAMBI <span style="color: #0070C0;">new</span>	20 W	2700 K	E	1910 lm	CA2307LC	370,97 €
				3000 K	E	2010 lm	CA2308LC	
●	Aluminiumglanz finish aluminum gloss finish	TRIAC	20 W	2700 K	E	1910 lm	CA2313L	325,17 €
				3000 K	E	2010 lm	CA2314L	
		DALI	20 W	2700 K	E	1910 lm	CA2317L	384,70 €
				3000 K	E	2010 lm	CA2318L	
		CASAMBI <span style="color: #0070C0;">new</span>	20 W	2700 K	E	1910 lm	CA2313LC	412,18 €
				3000 K	E	2010 lm	CA2314LC	

Abbildung figure	Beschreibung description	Regelung control	Leistung power	CCT	E EK EEC	Lumen lumen	Art.-Nr. art.-no.	€ netto CH excl. VAT
●	<b>Bronze finish</b> bronze finish	TRIAC	20 W	2700 K	E	1910 lm	CA2319L	325,17 €
				3000 K	E	2010 lm	CA2320L	
		DALI	20 W	2700 K	E	1910 lm	CA2323L	384,70 €
				3000 K	E	2010 lm	CA2324L	
		CASAMBI <b>new</b>	20 W	2700 K	E	1910 lm	CA2319LC	412,18 €
				3000 K	E	2010 lm	CA2320LC	

IP40 protection class	through wiring	glass lens	cut 100 mm	driver included	emergency light option	battery option	individual	LED	dimmable	Zhaga standard	CRI >97	SDCM 2
-----------------------------	-------------------	---------------	---------------	--------------------	---------------------------	-------------------	------------	-----	----------	-------------------	---------	--------

## CAVITY Recessed L **new**

Abbildung figure	Beschreibung description	Regelung control	Leistung power	CCT	E EK EEC	Lumen lumen	Art.-Nr. art.-no.	€ netto CH excl. VAT
●	<b>schwarz</b> black	TRIAC	20 W	2700 K	F	1910 lm	CA2301	261,06 €
				3000 K	E	2010 lm	CA2302	
		DALI	20 W	2700 K	F	1910 lm	CA2305	316,01 €
				3000 K	E	2010 lm	CA2306	
		CASAMBI <b>new</b>	20 W	2700 K	F	1910 lm	CA2305C	343,49 €
				3000 K	E	2010 lm	CA2306C	
○	<b>weiß</b> white	TRIAC	20 W	2700 K	F	1910 lm	CA2307	261,06 €
				3000 K	E	2010 lm	CA2308	
		DALI	20 W	2700 K	F	1910 lm	CA2311	316,01 €
				3000 K	E	2010 lm	CA2312	
		CASAMBI <b>new</b>	20 W	2700 K	F	1910 lm	CA2311C	343,49 €
				3000 K	E	2010 lm	CA2312C	
●	<b>Aluminiumglanz finish</b> aluminum gloss finish	TRIAC	20 W	2700 K	F	1910 lm	CA2313	302,27 €
				3000 K	E	2010 lm	CA2314	
		DALI	20 W	2700 K	F	1910 lm	CA2317	357,23 €
				3000 K	E	2010 lm	CA2318	
		CASAMBI <b>new</b>	20 W	2700 K	F	1910 lm	CA2317C	389,28 €
				3000 K	E	2010 lm	CA2318C	
●	<b>Bronze finish</b> bronze finish	TRIAC	20 W	2700 K	F	1910 lm	CA2319	302,27 €
				3000 K	E	2010 lm	CA2320	
		DALI	20 W	2700 K	F	1910 lm	CA2323	357,23 €
				3000 K	E	2010 lm	CA2324	
		CASAMBI <b>new</b>	20 W	2700 K	F	1910 lm	CA2323C	389,28 €
				3000 K	E	2010 lm	CA2324C	

IP40 protection class	through wiring	glass diffusor	cut 100 mm	driver included	emergency light option	battery option	individual	LED	dimmable	Zhaga standard	CRI >97	SDCM 2
-----------------------------	-------------------	-------------------	---------------	--------------------	---------------------------	-------------------	------------	-----	----------	-------------------	---------	--------

# CAVITY Suspension

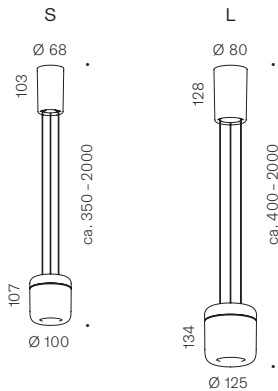

**Winkeladapter für Dachschrägen in weiß oder schwarz erhältlich – Montagehilfe für einfache Installation. Der Winkel kann individuell angefertigt werden – Sonderfarben auf Anfrage. Bestellungen (Art.-Nr.: weiß ZB1013, schwarz ZB1014) bitte in Abstimmung mit dem Vertrieb.**

Angle brackets for sloping roofs available in white or black - to assist with easy installation. The brackets can be made to measure - special colours available on request. Please coordinate orders (art.-no.: white ZB1013, black ZB1014) with the sales department.

## CAVITY Suspension S new

Abbildung figure	Beschreibung description	Regelung control	Leistung power	CCT	EEL EEC	Lumen lumen	Art.-Nr. art.-no.	€ netto CH excl. VAT
●	schwarz black	TRIAC	12 W	2700 K	F	950 lm	CA1101	375,55 €
				3000 K	E	1000 lm	CA1102	
		DALI <span style="color: blue;">new</span>	12 W	2700 K	F	950 lm	CA1111	421,34 €
				3000 K	E	1000 lm	CA1112	
		CASAMBI <span style="color: blue;">new</span>	12 W	2700 K	F	950 lm	CA1101C	457,99 €
				3000 K	E	1000 lm	CA1102C	
○	weiß white	TRIAC	12 W	2700 K	F	950 lm	CA1103	375,55 €
				3000 K	E	1000 lm	CA1104	
		DALI <span style="color: blue;">new</span>	12 W	2700 K	F	950 lm	CA1113	421,34 €
				3000 K	E	1000 lm	CA1114	
		CASAMBI <span style="color: blue;">new</span>	12 W	2700 K	F	950 lm	CA1103C	457,99 €
				3000 K	E	1000 lm	CA1104C	
●	Aluminiumglanz finish aluminum gloss finish	TRIAC	12 W	2700 K	F	950 lm	CA1105	448,82 €
				3000 K	E	1000 lm	CA1106	
		DALI <span style="color: blue;">new</span>	12 W	2700 K	F	950 lm	CA1115	499,20 €
				3000 K	E	1000 lm	CA1116	
		CASAMBI <span style="color: blue;">new</span>	12 W	2700 K	F	950 lm	CA1105C	535,84 €
				3000 K	E	1000 lm	CA1106C	
●	Bronze finish bronze finish	TRIAC	12 W	2700 K	F	950 lm	CA1107	448,82 €
				3000 K	E	1000 lm	CA1108	
		DALI <span style="color: blue;">new</span>	12 W	2700 K	F	950 lm	CA1117	499,20 €
				3000 K	E	1000 lm	CA1118	
		CASAMBI <span style="color: blue;">new</span>	12 W	2700 K	F	950 lm	CA1107C	535,84 €
				3000 K	E	1000 lm	CA1108C	

IP40   
protection class glass diffusor

LED  dimmable  Zhaga standard  CRI > 97  SDCM 2

# CAVITY Suspension L new

Abbildung figure	Beschreibung description	Regelung control	Leistung power	CCT	E EK EEC	Lumen lumen	Art.-Nr. art.-no.	€ netto CH excl. VAT
●	<b>schwarz</b> black	TRIAC	20 W	2700 K	F	1910lm	CA2101	522,10 €
				3000 K	E	2010lm	CA2102	
		DALI <span style="color: #0070C0;">new</span>	20 W	2700 K	F	1910lm	CA2105	581,63 €
				3000 K	E	2010lm	CA2106	
		CASAMBI <span style="color: #0070C0;">new</span>	20 W	2700 K	F	1910lm	CA2101C	613,70 €
				3000 K	E	2010lm	CA2102C	
○	<b>weiß</b> white	TRIAC	20 W	2700 K	F	1910lm	CA2107	522,10 €
				3000 K	E	2010lm	CA2108	
		DALI <span style="color: #0070C0;">new</span>	20 W	2700 K	F	1910lm	CA2111	581,63 €
				3000 K	E	2010lm	CA2112	
		CASAMBI <span style="color: #0070C0;">new</span>	20 W	2700 K	F	1910lm	CA2107C	613,70 €
				3000 K	E	2010lm	CA2108C	
●	<b>Aluminiumglanz finish</b> aluminum gloss finish	TRIAC	20 W	2700 K	F	1910lm	CA2113	622,86 €
				3000 K	E	2010lm	CA2114	
		DALI <span style="color: #0070C0;">new</span>	20 W	2700 K	F	1910lm	CA2117	682,39 €
				3000 K	E	2010lm	CA2118	
		CASAMBI <span style="color: #0070C0;">new</span>	20 W	2700 K	F	1910lm	CA2113C	709,87 €
				3000 K	E	2010lm	CA2114C	
●	<b>Bronze finish</b> bronze finish	TRIAC	20 W	2700 K	F	1910lm	CA2119	622,86 €
				3000 K	E	2010lm	CA2120	
		DALI <span style="color: #0070C0;">new</span>	20 W	2700 K	F	1910lm	CA2123	682,39 €
				3000 K	E	2010lm	CA2124	
		CASAMBI <span style="color: #0070C0;">new</span>	20 W	2700 K	F	1910lm	CA2119C	709,87 €
				3000 K	E	2010lm	CA2120C	

IP40   
protection class glass diffusor



LED  dimmable  Zhaga standard  CRI > 97  SDCM 2

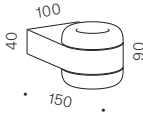



# CAVITY Wall



## CAVITY Wall S Linse 46° new

Abbildung figure	Beschreibung description	Regelung control	Leistung power	CCT	EEK EEC	Lumen lumen	Art.-Nr. art.-no.	€ netto CH excl. VAT
●	schwarz black	TRIAC	20W	2700K	E	1900lm	CA2401	343,49 €
				3000K	E	2000lm	CA2402	
		DALI <span style="color: blue; font-weight: bold;">new</span>	20W	2700K	E	1900lm	CA2411	375,55 €
				3000K	E	2000lm	CA2412	
		CASAMBI <span style="color: blue; font-weight: bold;">new</span>	20W	2700K	E	1900lm	CA2401C	462,56 €
				3000K	E	2000lm	CA2402C	
○	weiß white	TRIAC	20W	2700K	E	1900lm	CA2405	343,49 €
				3000K	E	2000lm	CA2406	
		DALI <span style="color: blue; font-weight: bold;">new</span>	20W	2700K	E	1900lm	CA2415	375,55 €
				3000K	E	2000lm	CA2416	
		CASAMBI <span style="color: blue; font-weight: bold;">new</span>	20W	2700K	E	1900lm	CA2405C	462,56 €
				3000K	E	2000lm	CA2406C	
●○	schwarz/weiß black/white	TRIAC	20W	2700K	E	1900lm	CA2461	343,49 €
				3000K	E	2000lm	CA2462	
		DALI <span style="color: blue; font-weight: bold;">new</span>	20W	2700K	E	1900lm	CA2471	375,55 €
				3000K	E	2000lm	CA2472	
		CASAMBI <span style="color: blue; font-weight: bold;">new</span>	20W	2700K	E	1900lm	CA2461C	462,56 €
				3000K	E	2000lm	CA2462C	
●●	schwarz/aluminiumglanz finish black/aluminum gloss finish	TRIAC	20W	2700K	E	1900lm	CA2441	393,86 €
				3000K	E	2000lm	CA2442	
		DALI <span style="color: blue; font-weight: bold;">new</span>	20W	2700K	E	1900lm	CA2451	421,34 €
				3000K	E	2000lm	CA2452	
		CASAMBI <span style="color: blue; font-weight: bold;">new</span>	20W	2700K	E	1900lm	CA2441C	485,46 €
				3000K	E	2000lm	CA2442C	
●●●	schwarz/Bronze finish black/ bronze finish	TRIAC	20W	2700K	E	1900lm	CA2421	393,86 €
				3000K	E	2000lm	CA2422	
		DALI <span style="color: blue; font-weight: bold;">new</span>	20W	2700K	E	1900lm	CA2431	421,34 €
				3000K	E	2000lm	CA2432	
		CASAMBI <span style="color: blue; font-weight: bold;">new</span>	20W	2700K	E	1900lm	CA2421C	485,46 €
				3000K	E	2000lm	CA2422C	
●○●	weiß/schwarz white/white	TRIAC	20W	2700K	E	1900lm	CA2465	343,49 €
				3000K	E	2000lm	CA2466	
		DALI <span style="color: blue; font-weight: bold;">new</span>	20W	2700K	E	1900lm	CA2475	375,55 €
				3000K	E	2000lm	CA2476	
		CASAMBI <span style="color: blue; font-weight: bold;">new</span>	20W	2700K	E	1900lm	CA2465C	462,56 €
				3000K	E	2000lm	CA2466C	

Abbildung figure	Beschreibung description	Regelung control	Leistung power	CCT	EEL EEC	Lumen lumen	Art.-Nr. art.-no.	€ netto CH excl. VAT
	<b>weiß/aluminiumglanz finish</b> white/aluminum gloss finish	TRIAC	20 W	2700 K	E	1900 lm	CA2445	393,86 €
				3000 K	E	2000 lm	CA2446	
		DALI <small>new</small>	20 W	2700 K	E	1900 lm	CA2455	421,34 €
				3000 K	E	2000 lm	CA2456	
		CASAMBI <small>new</small>	20 W	2700 K	E	1900 lm	CA2445C	485,46 €
				3000 K	E	2000 lm	CA2446C	
	<b>weiß/ Bronze finish</b> white/bronze finish	TRIAC	20 W	2700 K	E	1900 lm	CA2425	393,86 €
				3000 K	E	2000 lm	CA2426	
		DALI <small>new</small>	20 W	2700 K	E	1900 lm	CA2435	421,34 €
				3000 K	E	2000 lm	CA2436	
		CASAMBI <small>new</small>	20 W	2700 K	E	1900 lm	CA2425C	485,46 €
				3000 K	E	2000 lm	CA2426C	

 IP40  
protection class
  through wiring
  glass lens
  individual

LED
  dimmable
  Zhaga standard
  CRI > 97
  SDCM 2

# CLUB Floor

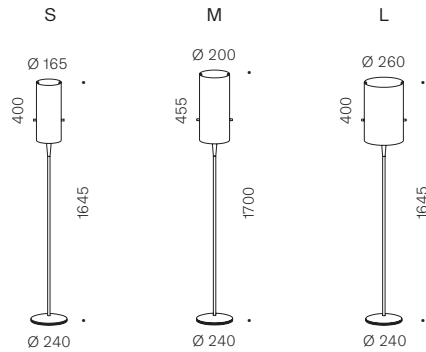

## CLUB Floor

Abbildung figure	Beschreibung description	Regelung control	Leistung power	CCT	EEK EEC	Lumen lumen	Art.-Nr. art.-no.	€ netto CH excl. VAT
	<b>S gebürstet, Chintz weiß</b> S brushed, Chintz white	integr.	20 W	2700 K	F	2060 lm	CL2101	915,97 €
	<b>S schwarz, Chintz weiß</b> S black, Chintz white	integr.	20 W	2700 K	F	2060 lm	CL2102	
	<b>S gebürstet, Melange grau</b> S brushed, Melange grey	integr.	20 W	2700 K	F	2060 lm	CL2103	
	<b>S schwarz, Melange grau</b> S black, Melange grey	integr.	20 W	2700 K	F	2060 lm	CL2104	
	<b>M gebürstet, Chintz weiß</b> M brushed, Chintz white	integr.	20 W	2700 K	F	2060 lm	CL2111	915,97 €
	<b>M schwarz, Chintz weiß</b> M black, Chintz white	integr.	20 W	2700 K	F	2060 lm	CL2112	
	<b>M gebürstet, Melange grau</b> M brushed, Melange grey	integr.	20 W	2700 K	F	2060 lm	CL2113	
	<b>M schwarz, Melange grau</b> M black, Melange grey	integr.	20 W	2700 K	F	2060 lm	CL2114	
	<b>L gebürstet, Chintz weiß</b> L brushed, Chintz white	integr.	20 W	2700 K	F	2060 lm	CL2121	915,97 €
	<b>L schwarz, Chintz weiß</b> L black, Chintz white	integr.	20 W	2700 K	F	2060 lm	CL2122	
	<b>L gebürstet, Melange grau</b> L brushed, Melange grey	integr.	20 W	2700 K	F	2060 lm	CL2123	
	<b>L schwarz, Melange grau</b> L black, Melange grey	integr.	20 W	2700 K	F	2060 lm	CL2124	

IP20  
protection  
class

LED



dimmable



Zhaga  
standard



CRI >97



SDCM 2

# CLUB Wall



## CLUB Wall

Abbildung figure	Beschreibung description	Fassung Socket	Regelung control	Leistung power	CCT	EEK EEC	Lumen lumen	Art.-Nr. art.-no.	€ netto CH excl. VAT
	<b>gebürstet, Chintz weiß</b> brushed, Chintz white	R7s	TRIAC	15 W	2700 K	E	2000lm	CL1075	279,37 €
	<b>schwarz, Chintz weiß</b> black, Chintz white	R7s	TRIAC	15 W	2700 K	E	2000lm	CL1065	
	<b>gebürstet, Melange grau</b> brushed, Melange grey	R7s	TRIAC	15 W	2700 K	E	2000lm	CL2131	
	<b>schwarz, Melange grau</b> black, Melange grey	R7s	TRIAC	15 W	2700 K	E	2000lm	CL2132	

IP20  
 protection class

through wiring

lamp included

dimmable

# CRIB Wall

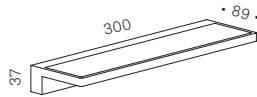

## CRIB Wall

Abbildung figure	Beschreibung description	Regelung control	Leistung power	CCT	EEK EEC	Lumen lumen	Art.-Nr. art.-no.	€ netto CH excl. VAT
	<b>schwarz</b> black	TRIAC	12 W	2700 K	F	1260lm	CR1001	421,34 €
	<b>weiß</b> white	TRIAC	12 W	2700 K	F	1260lm	CR1002	
	<b>Edelstahl finish</b> stainless steel finish	TRIAC	12 W	2700 K	F	1260lm	CR1003	467,14 €
	<b>Chrom finish</b> chrome finish	TRIAC	12 W	2700 K	F	1260lm	CR1005	

IP20 protection class  
 glass cover

LED dimmable CRI >90 SDCM 3

## Zubehör/Accessories

Abbildung figure	Beschreibung description	Art.-Nr. art.-no.	€ netto CH excl. VAT
	<b>Spiegeladapter Set</b> mirror adapter set	ZB1001	41,22 €

# CURLING Ceiling



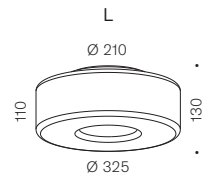
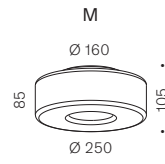
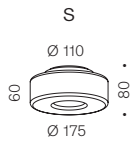
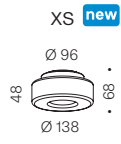



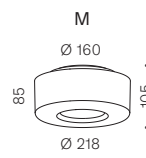
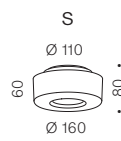
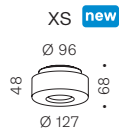

genuine glass







acrylic glass







## CURLING Ceiling XS new

Abbildung figure	Beschreibung description	Regelung control	Leistung power	CCT	EK EEC	Lumen lumen	Art.-Nr. art.-no.	€ netto CH excl. VAT
	<b>LIGHT ENGINE</b> Ceiling/Wall XS	TRIAC	8 W	2700 K	E	690 lm	LE015750	141,97 €
				3000 K	E	710 lm	LE015751	
		DALI	8 W	2700 K	E	690 lm	LE015753	164,87 €
				3000 K	E	710 lm	LE015754	
		CASAMBI	8 W	2700 K	E	690 lm	LE015753C	233,58 €
				3000 K	E	710 lm	LE015754C	
	<b>Glas XS klar</b> glass XS clear			<b>mit Optik Glaslinse eng 40°, Fassung Aluminium poliert</b> with optic glass lens narrow 40°, polished aluminium housing		CU014480	174,03 €	
				<b>mit Optik Glaslinse weit 55°, Fassung Aluminium poliert</b> with optic glass lens wide 55°, socket aluminium polished		CU014481		
	<b>Glas XS klar, Reflektor konisch</b> glass XS clear, reflector conical			<b>mit Echtglas Diffusor</b> with glass diffusor		CU014420	164,87 €	
	<b>Glas XS klar, Reflektor zylindrisch</b> glass XS clear, reflector cylindrical			<b>mit Echtglas Diffusor</b> with glass diffusor		CU014421		
	<b>Glas XS opal</b> glass XS opal			<b>mit Echtglas Diffusor</b> with glass diffusor		CU014418	146,55 €	
	<b>Glas XS neusilber</b> glass XS new silver			<b>mit Echtglas Diffusor</b> with glass diffusor		CU014430	224,41 €	
	<b>Acrylglas XS klar</b> acrylic glass XS clear			<b>mit Echtglas Diffusor</b> with glass diffusor		CU014424	59,54 €	
	<b>Acrylglas XS klar, Reflektor konisch</b> acrylic glass XS clear, reflector conical			<b>mit Echtglas Diffusor</b> with glass diffusor		CU014426	77,86 €	
	<b>Acrylglas XS klar, Reflektor zylindrisch</b> acrylic glass XS clear, reflector cylindrical			<b>mit Echtglas Diffusor</b> with glass diffusor		CU014427		

















 modular article  
 IP44 protection class  
 through wiring  
 glass diffusor

 LED  
 dimmable  
 Zhaga standard  
 CRI >97  
 SDCM 2





## CURLING Optik/optic XS new

Abbildung figure	Beschreibung description	Art.-Nr. art.-no.	€ netto CH excl. VAT
	<b>Optik XS Glaslinse eng 40°, Fassung transluzent</b> optic XS glass lens narrow 40°, socket translucent	<b>empfohlen für Ausführungen mit Reflektor</b> recommended for versions with reflector	32,97 €
	<b>Optik XS Glaslinse weit 55°, Fassung transluzent</b> optic XS glass lens wide 55°, socket translucent	<b>empfohlen für Ausführungen mit Reflektor</b> recommended for versions with reflector	
	<b>Optik XS Glaslinse eng 40°, Fassung Aluminium poliert</b> optic XS glass lens narrow 40°, socket aluminium polished	<b>empfohlen für Glas/Acrylglas klar</b> recommended for glass/acrylic glass clear	43,97 €
	<b>Optik XS Glaslinse weit 55°, Fassung Aluminium poliert</b> optic XS glass lens wide 55°, socket aluminium polished	<b>empfohlen für Glas/Acrylglas klar</b> recommended for glass/acrylic glass clear	
	<b>Optik XS Microprismatik Kegelkuppen 60° entblendet</b> optic XS microprismatic cone domes 60° glare-free	<b>für alle Versionen geeignet</b> suitable for all versions	23,82 €
	<b>Optik XS abgeblendet</b> optic XS deglared	<b>für alle Versionen geeignet</b> suitable for all versions	20,15 €



















## CURLING Ceiling S new

Abbildung figure	Beschreibung description	Regelung control	Leistung power	CCT	EEL EEC	Lumen lumen	Art.-Nr. art.-no.	€ netto CH excl. VAT	
	<b>LIGHT ENGINE</b> Ceiling/Wall S	TRIAC	11 W	2700 K	E	1170 lm	LE015701	206,10 €	
				3000 K	E	1230 lm	LE015702		
				4000 K <span style="color: #0070C0;">new</span>	E	1280 lm	LE015733		
				1800-3000 K dim2warm	F	870 lm	LE015703		247,31 €
				2700 K	E	1170 lm	LE015730		233,58 €
				3000 K	E	1230 lm	LE015731		
		4000 K <span style="color: #0070C0;">new</span>	E	1280 lm	LE015734				
		CASAMBI <span style="color: #0070C0;">new</span>	11 W		1800-3000 K dim2warm	F	870 lm	LE015732	274,79 €
					2700 K	E	1170 lm	LE015701C	297,69 €
					3000 K	E	1230 lm	LE015702C	
					4000 K	E	1280 lm	LE015733C	
					1800-3000 K dim2warm	F	870 lm	LE015703C	
	<b>Glas S klar</b> glass S clear						mit Optik Glaslinse eng 32°, Fassung Aluminium poliert with optic glass lens narrow 32°, socket aluminium polished		CU014482
		mit Optik Glaslinse weit 59°, Fassung Aluminium poliert with optic glass lens wide 59°, socket aluminium polished		CU014483					
	<b>Glas S klar, Reflektor konisch</b> glass S clear, reflector conical			mit Echtglas Diffusor with glass diffuser		CU014407	228,99 €		
	<b>Glas S klar, Reflektor zylindrisch</b> glass S clear, reflector cylindrical			mit Echtglas Diffusor with glass diffuser		CU014408			
	<b>Glas S opal</b> glass S opal			mit Echtglas Diffusor with glass diffuser		CU014405	196,93 €		
	<b>Glas S neusilber</b> glass S new silver			mit Echtglas Diffusor with glass diffuser		CU011201	293,11 €		
	<b>Acrylglas S klar</b> acrylic glass S clear			mit Optik Pure (entblendet) with optic Pure (glare-free)		CU011203	87,01 €		
	<b>Acrylglas S klar, Reflektor konisch</b> acrylic glass S clear, reflector conical			mit Echtglas Diffusor with glass diffuser		CU011204	105,34 €		
	<b>Acrylglas S klar, Reflektor zylindrisch</b> acrylic glass S clear, reflector cylindrical			mit Echtglas Diffusor with glass diffuser		CU011205			
 <b>IP40</b>									
modular article	protection class	through wiring							
			LED						
				dimmable	Zhaga standard	dim2warm	CRI >97	SDCM 2	





## CURLING Optik/optic S new

Abbildung figure	Beschreibung description	Art.-Nr. art.-no.	€ netto CH excl. VAT
	<b>Optik S Glaslinse eng 32°, Fassung transluzent</b> optic S glass lens narrow 32°, socket translucent	<b>empfohlen für Ausführungen mit Reflektor</b> recommended for versions with reflector	CU8543
	<b>Optik S Glaslinse weit 59°, Fassung transluzent</b> optic S glass lens wide 59°, socket translucent	<b>empfohlen für Ausführungen mit Reflektor</b> recommended for versions with reflector	CU8552
	<b>Optik S Glaslinse eng 32°, Fassung Aluminium poliert</b> optic S glass lens narrow 32°, socket aluminium polished	<b>empfohlen für Glas/Acrylglas klar</b> recommended for glass/acrylic glass clear	CU8545
	<b>Optik S Glaslinse weit 59°, Fassung Aluminium poliert</b> optic S glass lens wide 59°, socket aluminium polished	<b>empfohlen für Glas/Acrylglas klar</b> recommended for glass/acrylic glass clear	CU8553
	<b>Optik S Microprismatik Kegeldkuppen 60° entblendet</b> optic S microprismatic cone domes 60° glare-free	<b>für alle Versionen geeignet</b> suitable for all versions	CU8539
	<b>Optik S abgeblendet</b> optic S deglared	<b>für alle Versionen geeignet</b> suitable for all versions	CU8532
			42,14 €
			49,46 €
			27,48 €
			22,90 €















## CURLING Ceiling M new

Abbildung figure	Beschreibung description	Regelung control	Leistung power	CCT	EK EEC	Lumen lumen	Art.-Nr. art.-no.	€ netto CH excl. VAT		
	<b>LIGHT ENGINE</b> Ceiling/Wall M	TRIAC	20 W	2700 K	F	1910 lm	LE015710	274,79 €		
				3000 K	E	2010 lm	LE015711			
				4000 K <span style="color: #0070C0;">new</span>	E	2080 lm	LE015770			
				1800-3000 K dim2warm	F	1540 lm	LE015712		274,79 €	
				2700 K	F	1910 lm	LE015713		302,27 €	
				3000 K	E	2010 lm	LE015714			
		4000 K <span style="color: #0070C0;">new</span>	E	2080 lm	LE015771					
		1800-3000 K dim2warm	F	1540 lm	LE015715	338,90 €				
		2700 K	F	1910 lm	LE015713C	393,86 €				
		3000 K	E	2010 lm	LE015714C					
		4000 K	E	2080 lm	LE015770C					
		1800-3000 K dim2warm	F	1540 lm	LE015715C		430,51 €			
	<b>Glas M klar</b> glass M clear	mit Optik Glaslinse eng 35°, Fassung Aluminium poliert with optic glass lens narrow 35°, socket aluminium polished					CU014484	297,69 €		
		mit Optik Glaslinse weit 48°, Fassung Aluminium poliert with optic glass lens wide 48°, socket aluminium polished					CU014485			
	<b>Glas M klar, Reflektor konisch</b> glass M clear, reflector conical	mit Echtglas Diffusor with glass diffuser				CU014403	288,53 €			
	<b>Glas M klar, Reflektor zylindrisch</b> glass M clear, reflector cylindrical	mit Echtglas Diffusor with glass diffuser				CU014404				
	<b>Glas M opal</b> glass M opal	mit Echtglas Diffusor with glass diffuser				CU014401	247,31 €			
	<b>Glas M neusilber</b> glass M new silver	mit Echtglas Diffusor with glass diffuser				CU011202	370,97 €			
	<b>Acrylglas M klar</b> acrylic glass M clear	mit Optik Pure (entblendet) with optic Pure (glare-free)				CU011206	114,49 €			
	<b>Acrylglas M klar, Reflektor konisch</b> acrylic glass M clear, reflector conical	mit Echtglas Diffusor with glass diffuser				CU011207	146,55 €			
	<b>Acrylglas M klar, Reflektor zylindrisch</b> acrylic glass M clear, reflector cylindrical	mit Echtglas Diffusor with glass diffuser				CU011208				
	IP40				LED					
modular article	protection class	through wiring	emergency light option	battery option		dimmable	Zhaga standard	dim2warm	CRI >97	SDCM 2





## CURLING Optik/optic M new

Abbildung figure	Beschreibung description	Art.-Nr. art.-no.	€ netto CH excl. VAT	
	<b>Optik M/L Glaslinse eng 35°, Fassung transluzent</b> optic M/L glass lens narrow 35°, socket translucent	empfohlen für Ausführungen mit Reflektor recommended for versions with reflector	CU8555	
	<b>Optik M/L Glaslinse weit 48°, Fassung transluzent</b> optic M/L glass lens wide 48°, socket translucent	empfohlen für Ausführungen mit Reflektor recommended for versions with reflector	CU8542	50,38 €
	<b>Optik M/L Glaslinse eng 35°, Fassung Aluminium poliert</b> optic M/L glass lens narrow 35°, socket aluminium polished	empfohlen für Glas/Acrylglas klar recommended for glass/acrylic glass clear	CU8554	
	<b>Optik M/L Glaslinse weit 48°, Fassung Aluminium poliert</b> optic M/L glass lens wide 48°, socket aluminium polished	empfohlen für Glas/Acrylglas klar recommended for glass/acrylic glass clear	CU8546	59,54 €
	<b>Optik M Microprismatik Kegelkuppen 60° entblendet</b> optic M microprismatic cone domes 60° glare-free	für alle Versionen geeignet suitable for all versions	CU8536	43,97 €
	<b>Optik M abgeblendet</b> optic M deglared	für alle Versionen geeignet suitable for all versions	CU8535	38,47 €

## CURLING Ceiling L new

Abbildung figure	Beschreibung description	Regelung control	Leistung power	CCT	EEK EEC	Lumen lumen	Art.-Nr. art.-no.	€ netto CH excl. VAT			
	<b>LIGHT ENGINE</b> Ceiling/Wall L	TRIAC	34 W	2700 K	F	3300 lm	LE014480	329,75 €			
				3000 K	F	3450 lm	LE014483				
				4000 K <span style="color: #0070C0;">new</span>	F	3570 lm	LE015762				
		DALI	34 W	2700 K	F	3300 lm	LE014478	357,23 €			
				3000 K	F	3450 lm	LE014481				
				4000 K <span style="color: #0070C0;">new</span>	F	3570 lm	LE015763				
CASAMBI <span style="color: #0070C0;">new</span>	34 W	2700 K	F	3300 lm	LE014480C	421,34 €					
		3000 K	F	3450 lm	LE014483C						
		4000 K	F	3570 lm	LE015763C						
	<b>Glas L klar</b> glass L clear	<b>mit Optik Glaslinse eng 35°, Fassung Aluminium poliert</b> with optic glass lens narrow 35°, socket aluminium polished					CU014486	403,03 €			
		<b>mit Optik Glaslinse weit 48°, Fassung Aluminium poliert</b> with optic glass lens wide 48°, socket aluminium polished					CU014487				
	<b>Glas L klar, Reflektor konisch</b> glass L clear, reflector conical	<b>mit Echtglas Diffusor</b> with glass diffusor					CU014476	393,86 €			
	<b>Glas L klar, Reflektor zylindrisch</b> glass L clear, reflector cylindrical	<b>mit Echtglas Diffusor</b> with glass diffusor					CU014477				
	<b>Glas L opal</b> glass L opal	<b>mit Echtglas Diffusor</b> with glass diffusor					CU014479	380,13 €			
	<b>Glas L neusilber</b> glass L new silver	<b>mit Echtglas Diffusor</b> with glass diffusor					CU014478	453,41 €			
 <b>IP40</b> protection class	 <b>through wiring</b>	 <b>emergency light option</b>	 <b>battery option</b>	<b>LED</b>				 <b>dimmable</b>	 <b>Zhaga standard</b>	 <b>CRI &gt;97</b>	 <b>SDCM 2</b>

## CURLING Optik/optic L new

Abbildung figure	Beschreibung description	Art.-Nr. art.-no.	€ netto CH excl. VAT
	<b>Optik M/L Glaslinse eng 35°, Fassung transluzent</b> optic M/L glass lens, narrow 35°, socket translucent	<b>empfohlen für Ausführungen mit Reflektor</b> recommended for versions with reflector	CU8555
	<b>Optik M/L Glaslinse weit 48°, Fassung transluzent</b> optic M/L glass lens wide 48°, socket translucent	<b>empfohlen für Ausführungen mit Reflektor</b> recommended for versions with reflector	CU8542
	<b>Optik M/L Glaslinse eng 35°, Fassung Aluminium poliert</b> optic M/L glass lens narrow 35°, socket aluminium polished	<b>empfohlen für Glas/Acrylglas klar</b> recommended for glass/acrylic glass clear	CU8554
	<b>Optik M/L Glaslinse weit 48°, Fassung Aluminium poliert</b> optic M/L glass lens wide 48°, socket aluminium polished	<b>empfohlen für Glas/Acrylglas klar</b> recommended for glass/acrylic glass clear	CU8546
	<b>Optik L Microprismatik Kegelkuppen 60° entblendet</b> optic L microprismatic cone domes 60° glare-free	<b>für alle Versionen geeignet</b> suitable for all versions	CU8541
	<b>Optik L abgeblendet</b> optic L deglared	<b>für alle Versionen geeignet</b> suitable for all versions	CU8537

# CURLING Suspension

genuine glass

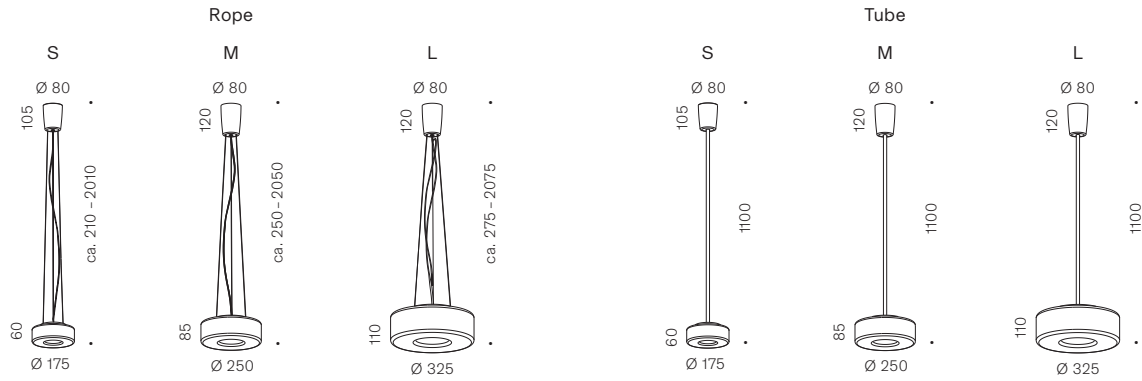

acrylic glass



**Winkeladapter für Dachschrägen in weiß erhältlich – Montagehilfe für einfache Installation.**

**Der Winkel kann individuell angefertigt werden – Sonderfarben auf Anfrage.**

**Bestellungen (Art.-Nr.: ZB1012) bitte in Abstimmung mit dem Vertrieb.**











Angle brackets for sloping roofs available in white – to assist with easy installation.





The brackets can be made to measure – special colours available on request.

Please coordinate orders (art.-no.: ZB1012) with the sales department.





## CURLING Suspension S new

Abbildung figure	Beschreibung description	Regelung control	Leistung power	CCT	EЕК EEC	Lumen lumen	Art.-Nr. art.-no.	€ netto CH excl. VAT
	LIGHT ENGINE Suspension Rope S	TRIAC	11 W	2700 K	E	1170 lm	LE015704	403,03 €
				3000 K	E	1230 lm	LE015705	
				4000 K <span style="background-color: #0070C0; color: white; padding: 2px;">new</span>	E	1280 lm	LE015738	
				1800-3000 K dim2warmF	870 lm	LE015706	435,08 €	
		DALI	11 W	2700 K	E	1170 lm	LE015735	435,08 €
				3000 K	E	1230 lm	LE015736	
				4000 K <span style="background-color: #0070C0; color: white; padding: 2px;">new</span>	E	1280 lm	LE015739	
				1800-3000 K dim2warmF	870 lm	LE015737	467,14 €	
		CASAMBI <span style="background-color: #0070C0; color: white; padding: 2px;">new</span>	11 W	2700 K	E	1170 lm	LE015704C	494,62 €
				3000 K	E	1230 lm	LE015736C	
				4000 K	E	1280 lm	LE015738C	
				1800-3000 K dim2warmF	870 lm	LE015737C	517,52 €	
	LIGHT ENGINE Suspension Tube S	TRIAC	11 W	2700 K	E	1170 lm	LE015707	357,23 €
				3000 K	E	1230 lm	LE015708	
				4000 K <span style="background-color: #0070C0; color: white; padding: 2px;">new</span>	E	1280 lm	LE015743	
				1800-3000 K dim2warmF	870 lm	LE015709	393,86 €	
		DALI	11 W	2700 K	E	1170 lm	LE015740	393,86 €
				3000 K	E	1230 lm	LE015741	
				4000 K <span style="background-color: #0070C0; color: white; padding: 2px;">new</span>	E	1280 lm	LE015744	
				1800-3000 K dim2warmF	870 lm	LE015742	425,93 €	
		CASAMBI <span style="background-color: #0070C0; color: white; padding: 2px;">new</span>	11 W	2700 K	E	1170 lm	LE015740C	448,82 €
				3000 K	E	1230 lm	LE015741C	
				4000 K	E	1280 lm	LE015743C	
				1800-3000 K dim2warmF	870 lm	LE015742C	485,46 €	
	<b>Glas S klar</b> glass S clear			mit Optik Glaslinse weit 59°, Fassung Aluminium poliert with optic glass lens wide 59°, socket aluminium polished		CU014483	238,15 €	
	<b>Glas S klar, Reflektor konisch</b> glass S clear, reflector conical			mit Echtglas Diffusor with glass diffuser		CU014407	228,99 €	
	<b>Glas S klar, Reflektor zylindrisch</b> glass S clear, reflector cylindrical			mit Echtglas Diffusor with glass diffuser		CU014408		
	<b>Glas S opal</b> glass S opal			mit Echtglas Diffusor with glass diffuser		CU014405	196,93 €	
	<b>Glas S neusilber</b> glass S new silver			mit Echtglas Diffusor with glass diffuser		CU011201	293,11 €	
	<b>Acrylglas S klar</b> acrylic glass S clear			mit Optik Pure (entblendet) with optic Pure (glare-free)		CU011203	87,01 €	
	<b>Acrylglas S klar, Reflektor konisch</b> acrylic glass S clear, reflector conical			mit Echtglas Diffusor with glass diffuser		CU011204	105,34 €	
	<b>Acrylglas S klar, Reflektor zylindrisch</b> acrylic glass S clear, reflector cylindrical			mit Echtglas Diffusor with glass diffuser		CU011205		





















 modular article
  IP20 protection class
  through wiring
  tube cuttable
  + length option

LED  dimmable
  Zhaga standard
  dim2warm
  CRI >97
  SDCM 3



## CURLING Optik/optic S new

Abbildung figure	Beschreibung description	Art.-Nr. art.-no.	€ netto CH excl. VAT	
	<b>Optik S Glaslinse eng 32°, Fassung transluzent</b> optic S glass lens narrow 32°, socket translucent	empfohlen für Ausführungen mit Reflektor recommended for versions with reflector	CU8543	
	<b>Optik S Glaslinse weit 59°, Fassung transluzent</b> optic S glass lens wide 59°, socket translucent	empfohlen für Ausführungen mit Reflektor recommended for versions with reflector	CU8552	42,14 €
	<b>Optik S Glaslinse eng 32°, Fassung Aluminium poliert</b> optic S glass lens narrow 32°, socket aluminium polished	empfohlen für Glas/Acrylglas klar recommended for glass/acrylic glass clear	CU8545	
	<b>Optik S Glaslinse weit 59°, Fassung Aluminium poliert</b> optic S glass lens wide 59°, socket aluminium polished	empfohlen für Glas/Acrylglas klar recommended for glass/acrylic glass clear	CU8553	49,46 €
	<b>Optik S Microprismatik Kegelkuppen 60° entblendet</b> optic S microprismatic cone domes 60° glare-free	für alle Versionen geeignet suitable for all versions	CU8539	27,48 €







## CURLING Suspension M new

Abbildung figure	Beschreibung description	Regelung control	Leistung CCT power	EЕК EEC	Lumen lumen	Art.-Nr. art.-no.	€ netto CH excl. VAT				
	LIGHT ENGINE Suspension Rope M	TRIAC	2700 K	F	1910 lm	LE015716	485,46 €				
			3000 K	E	2010 lm	LE015717					
			4000 K <span style="color: #0070C0;">new</span>	E	2080 lm	LE015772					
			1800-3000 K dim2warm	F	1540 lm	LE015718		526,68 €			
		DALI	2700 K	F	1910 lm	LE015719	517,52 €				
			3000 K	E	2010 lm	LE015720					
			4000 K <span style="color: #0070C0;">new</span>	E	2080 lm	LE015773					
			1800-3000 K dim2warm	F	1540 lm	LE015721		558,74 €			
		CASAMBI <span style="color: #0070C0;">new</span>	2700 K	F	1910 lm	LE015716C	572,48 €				
			3000 K	E	2010 lm	LE015720C					
			4000 K	E	2080 lm	LE015773C					
			1800-3000 K dim2warm	F	1540 lm	LE015718C		618,28 €			
	LIGHT ENGINE Suspension Tube M	TRIAC	2700 K	F	1910 lm	LE015722	435,08 €				
			3000 K	E	2010 lm	LE015723					
			4000 K <span style="color: #0070C0;">new</span>	E	2080 lm	LE015728					
			1800-3000 K dim2warm	F	1540 lm	LE015724		476,30 €			
DALI	2700 K	F	1910 lm	LE015725	467,14 €						
	3000 K	E	2010 lm	LE015726							
	4000 K <span style="color: #0070C0;">new</span>	E	2080 lm	LE015729							
	1800-3000 K dim2warm	F	1540 lm	LE015727		512,94 €					
CASAMBI <span style="color: #0070C0;">new</span>	2700 K	F	1910 lm	LE015722C	517,52 €						
	3000 K	E	2010 lm	LE015723C							
	4000 K	E	2080 lm	LE015729C							
	1800-3000 K dim2warm	F	1540 lm	LE015724C		549,58 €					
	<b>Glas M klar</b> glass M clear	mit <b>Optik Glaslinse weit 48°, Fassung Aluminium poliert</b> with optic glass lens wide 48°, socket aluminium polished		CU014485	297,69 €						
	<b>Glas M klar, Reflektor konisch</b> glass M clear, reflector conical	mit <b>Echtglas Diffusor</b> with glass diffuser		CU014403	288,53 €						
	<b>Glas M klar, Reflektor zylindrisch</b> glass M clear, reflector cylindrical	mit <b>Echtglas Diffusor</b> with glass diffuser		CU014404							
	<b>Glas M opal</b> glass M opal	mit <b>Echtglas Diffusor</b> with glass diffuser		CU014401	247,31 €						
	<b>Glas M neusilber</b> glass M new silver	mit <b>Echtglas Diffusor</b> with glass diffuser		CU011202	370,97 €						
	<b>Acrylglas M klar</b> acrylic glass M clear	mit <b>Optik Pure (entblendet)</b> with optic Pure (glare-free)		CU011206	114,49 €						
	<b>Acrylglas M klar, Reflektor konisch</b> acrylic glass M clear, reflector conical	mit <b>Echtglas Diffusor</b> with glass diffuser		CU011207	146,55 €						
	<b>Acrylglas M klar, Reflektor zylindrisch</b> acrylic glass M clear, reflector cylindrical	mit <b>Echtglas Diffusor</b> with glass diffuser		CU011208							
	IP20					LED					
modular article	protection class	through wiring	tube cuttable	+ length option	emergency light option		dimmable	Zhaga standard	dim2warm	CRI >97	SDCM 3

## CURLING Optik/optic M new

Abbildung figure	Beschreibung description	Art.-Nr. art.-no.	€ netto CH excl. VAT
	<b>Optik M/L Glaslinse eng 35°, Fassung transluzent</b> optic M/L glass lens narrow 35°, socket translucent	empfohlen für Ausführungen mit Reflektor recommended for versions with reflector	CU8555
	<b>Optik M/L Glaslinse weit 48°, Fassung transluzent</b> optic M/L glass lens wide 48°, socket translucent	empfohlen für Ausführungen mit Reflektor recommended for versions with reflector	CU8542
	<b>Optik M/L Glaslinse eng 35°, Fassung Aluminium poliert</b> optic M/L glass lens narrow 35°, socket aluminium polished	empfohlen für Glas/Acrylglas klar recommended for glass/acrylic glass clear	CU8554
	<b>Optik M/L Glaslinse weit 48°, Fassung Aluminium poliert</b> optic M/L glass lens wide 48°, socket aluminium polished	empfohlen für Glas/Acrylglas klar recommended for glass/acrylic glass clear	CU8546
	<b>Optik M Microprismatik Kegelkuppen 60° entblendet</b> optic M microprismatic cone domes 60° glare-free	für alle Versionen geeignet suitable for all versions	CU8536
			43,97 €



## CURLING Suspension L new

Abbildung figure	Beschreibung description	Regelung control	Leistung power	CCT	EЕК EEC	Lumen lumen	Art.-Nr. art.-no.	€ netto CH excl. VAT
	<b>LIGHT ENGINE</b> Suspension Rope L	TRIAC	34 W	2700 K	F	3300lm	LE014486	526,68 €
				3000 K	F	3450lm	LE014489	
				4000 K <span style="color: #0070C0;">new</span>	F	3570lm	LE015764	
		DALI	34 W	2700 K	F	3300lm	LE014484	567,90 €
				3000 K	F	3450lm	LE014487	
				4000 K <span style="color: #0070C0;">new</span>	F	3570lm	LE015765	
		CASAMBI <span style="color: #0070C0;">new</span>	34 W	2700 K	F	3300lm	LE014486C	618,28 €
				3000 K	F	3450lm	LE014489C	
				4000 K	F	3570lm	LE015764C	
	<b>LIGHT ENGINE</b> Suspension Tube L	TRIAC	34 W	2700 K	F	3300lm	LE014492	471,72 €
				3000 K	F	3450lm	LE014495	
				4000 K <span style="color: #0070C0;">new</span>	F	3570lm	LE015766	
		DALI	34 W	2700 K	F	3300lm	LE014490	517,52 €
				3000 K	F	3450lm	LE014493	
				4000 K <span style="color: #0070C0;">new</span>	F	3570lm	LE015767	
		CASAMBI <span style="color: #0070C0;">new</span>	34 W	2700 K	F	3300lm	LE014492C	563,32 €
				3000 K	F	3450lm	LE014495C	
				4000 K	F	3570lm	LE015766C	
	<b>Glas L klar</b> glass clear			<b>mit Optik Glaslinse weit 48°, Fassung Aluminium poliert</b> with optic glass lens wide 48°, socket aluminium polished		CU014487	403,03 €	
	<b>Glas L klar, Reflektor konisch</b> glass clear, reflector conical			<b>mit Echtglas Diffusor</b> with glass diffusor		CU014476	393,86 €	
	<b>Glas L klar, Reflektor zylindrisch</b> glass clear, reflector cylindrical			<b>mit Echtglas Diffusor</b> with glass diffusor		CU014477		
	<b>Glas L opal</b> glass L opal			<b>mit Echtglas Diffusor</b> with glass diffusor		CU014479	380,13 €	
	<b>Glas L neusilber</b> glass L new silver			<b>mit Echtglas Diffusor</b> with glass diffusor		CU014478	453,41 €	

 modular article  
  IP20 protection class  
  through wiring  
  tube cuttable  
  + length option  
  emergency light option  
  battery option

 LED  
  dimmable  
  Zhaga standard  
  CRI >97  
  SDCM 3

## CURLING Optik/optic L new

Abbildung figure	Beschreibung description	Art.-Nr. art.-no.	€ netto CH excl. VAT
	<b>Optik M/L Glaslinse eng 35°, Fassung transluzent</b> optic M/L glass lens, narrow 35°, socket translucent	<b>empfohlen für Ausführungen mit Reflektor</b> recommended for versions with reflector	50,38 €
	<b>Optik M/L Glaslinse weit 48°, Fassung transluzent</b> optic M/L glass lens wide 48°, socket translucent	<b>empfohlen für Ausführungen mit Reflektor</b> recommended for versions with reflector	
	<b>Optik M/L Glaslinse eng 35°, Fassung Aluminium poliert</b> optic M/L glass lens narrow 35°, socket aluminium polished	<b>empfohlen für Glas/Acrylglas klar</b> recommended for glass/acrylic glass clear	59,54 €
	<b>Optik M/L Glaslinse weit 48°, Fassung Aluminium poliert</b> optic M/L glass lens wide 48°, socket aluminium polished	<b>empfohlen für Glas/Acrylglas klar</b> recommended for glass/acrylic glass clear	
	<b>Optik L Microprismatik Kegelkuppen 60° entblendet</b> optic L microprismatic cone domes 60° glare-free	<b>für alle Versionen geeignet</b> suitable for all versions	52,21 €

# CURLING Wall

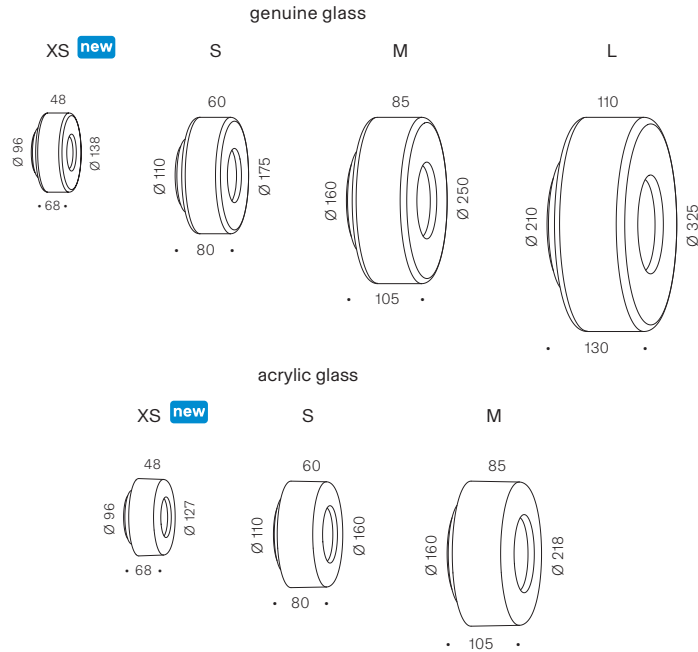











## CURLING Wall XS new

Abbildung figure	Beschreibung description	Regelung control	Leistung power	CCT	EEL EEC	Lumen lumen	Art.-Nr. art.-no.	€ netto CH excl. VAT
	<b>LIGHT ENGINE</b> Ceiling/Wall XS	TRIAC	8 W	2700 K	E	690 lm	LE015750	141,97 €
				3000 K	E	710 lm	LE015751	
		DALI	8 W	2700 K	E	690 lm	LE015753	164,87 €
				3000 K	E	710 lm	LE015754	
		CASAMBI	8 W	2700 K	E	690 lm	LE015753C	233,58 €
				3000 K	E	710 lm	LE015754C	
	<b>Glas XS klar</b> glass XS clear			<b>mit Optik XS abgeblendet</b> with optic XS deglared			CU014423	146,55 €
	<b>Glas XS klar, Reflektor konisch</b> glass XS clear, reflector conical			<b>mit Optik XS abgeblendet</b> with optic XS deglared			CU014428	164,87 €
	<b>Glas XS klar, Reflektor zylindrisch</b> glass XS clear, reflector cylindrical			<b>mit Optik XS abgeblendet</b> with optic XS deglared			CU014429	
	<b>Glas XS opal</b> glass XS opal			<b>mit Optik XS abgeblendet</b> with optic XS deglared			CU011240	146,55 €
	<b>Glas XS neusilber</b> glass XS new silver			<b>mit Optik XS verspiegelt</b> with optic XS mirrored			CU011244	224,41 €
	<b>Acrylglas XS klar</b> acrylic glass XS clear			<b>mit Optik XS abgeblendet</b> with optic XS deglared			CU014425	59,54 €
	<b>Acrylglas XS klar, Reflektor konisch</b> acrylic glass XS clear, reflector conical			<b>mit Optik XS abgeblendet</b> with optic XS deglared			CU011238	77,86 €
	<b>Acrylglas XS klar, Reflektor zylindrisch</b> acrylic glass XS clear, reflector cylindrical			<b>mit Optik XS abgeblendet</b> with optic XS deglared			CU011239	





## CURLING Wall S new

Abbildung figure	Beschreibung description	Regelung control	Leistung power	CCT	EЕК EEC	Lumen lumen	Art.-Nr. art.-no.	€ netto CH excl. VAT							
	<b>LIGHT ENGINE</b> Ceiling/Wall S	TRIAC	11 W	2700 K	E	1170 lm	LE015701	206,10 €							
				3000 K	E	1230 lm	LE015702								
				4000 K <span style="color: #0070C0;">new</span>	E	1280 lm	LE015733								
				1800-3000 K dim2warm	F	870 lm	LE015703		247,31 €						
				2700 K	E	1170 lm	LE015730		233,58 €						
				3000 K	E	1230 lm	LE015731								
		4000 K <span style="color: #0070C0;">new</span>	E	1280 lm	LE015734										
		DALI	11 W	1800-3000 K dim2warm	F	870 lm	LE015732	274,79 €							
									CASAMBI <span style="color: #0070C0;">new</span>	11 W	2700 K	E	1170 lm	LE015701C	297,69 €
											3000 K	E	1230 lm	LE015702C	
		4000 K	E	1280 lm	LE015733C										
						1800-3000 K dim2warm	F	870 lm	LE015703C	343,49 €					
	<b>Glas S klar</b> glass S clear			<b>mit Optik S abgeblendet</b> with optic S deglared			CU011212	228,99 €							
	<b>Glas S klar, Reflektor konisch</b> glass S clear, reflector conical			<b>mit Optik S abgeblendet</b> with optic S deglared			CU011225	256,47 €							
	<b>Glas S klar, Reflektor zylindrisch</b> glass S clear, reflector cylindrical			<b>mit Optik S abgeblendet</b> with optic S deglared			CU011226								
	<b>Glas S opal</b> glass S opal			<b>mit Optik S abgeblendet</b> with optic S deglared			CU011241	196,93 €							
	<b>Glas S neusilber</b> glass S new silver			<b>mit Optik S verspiegelt</b> with optic S mirrored			CU011245	320,59 €							
	<b>Acrylglas S klar</b> acrylic glass S clear			<b>mit Optik S abgeblendet</b> with optic S deglared			CU011220	114,49 €							
	<b>Acrylglas S klar, Reflektor konisch</b> acrylic glass S clear, reflector conical			<b>mit Optik S abgeblendet</b> with optic S deglared			CU011232	141,97 €							
	<b>Acrylglas S klar, Reflektor zylindrisch</b> acrylic glass S clear, reflector cylindrical			<b>mit Optik S abgeblendet</b> with optic S deglared			CU011233								



 IP40  
modular article protection class

LED  dimmable  Zhaga standard  dim2warm  CRI >97  SDCM 2









## CURLING Optik/optic XS new





Abbildung figure	Beschreibung description	Art.-Nr. art.-no.	€ netto CH excl. VAT
 <span style="color: #0070C0;">new</span>	<b>Optik XS abgeblendet</b> optic XS deglared	für alle Versionen geeignet suitable for all versions	CU8547 20,15 €
 <span style="color: #0070C0;">new</span>	<b>Optik XS verspiegelt</b> optic XS mirrored	für alle Versionen geeignet suitable for all versions	CU8559 20,15 €

## CURLING Optik/optic S new

Abbildung figure	Beschreibung description	Art.-Nr. art.-no.	€ netto CH excl. VAT
 <span style="color: #0070C0;">new</span>	<b>Optik S abgeblendet</b> optic S deglared	für alle Versionen geeignet suitable for all versions	CU8532 27,48 €
 <span style="color: #0070C0;">new</span>	<b>Optik S verspiegelt</b> optic S mirrored	für alle Versionen geeignet suitable for all versions	CU8560 27,48 €

## CURLING Wall M new

Abbildung figure	Beschreibung description	Regelung control	Leistung power	CCT	EELCC	Lumen lumen	Art.-Nr. art.-no.	€ netto CH excl. VAT	
	<b>LIGHT ENGINE</b> Ceiling/Wall M	TRIAC	20W	2700K	F	1910lm	LE015710	274,79 €	
				3000K	E	2010lm	LE015711		
				4000K <span style="color: #0070C0;">new</span>	E	2080lm	LE015770		
				1800-3000K dim2warm	F	1540lm	LE015712		274,79 €
				2700K	F	1910lm	LE015713		302,27 €
				3000K	E	2010lm	LE015714		
		4000K <span style="color: #0070C0;">new</span>	E	2080lm	LE015771				
		CASAMBI <span style="color: #0070C0;">new</span>	20W		1800-3000K dim2warm	F	1540lm	LE015715	338,90 €
					2700K	F	1910lm	LE015713C	393,86 €
					3000K	E	2010lm	LE015714C	
					4000K	E	2080lm	LE015770C	
					1800-3000K dim2warm	F	1540lm	LE015715C	
	<b>Glas M klar</b> glass M clear			<b>mit Optik M abgeblendet</b> with optic M deglared		CU011209	270,21 €		
	<b>Glas M klar, Reflektor konisch</b> glass M clear, reflector conical			<b>mit Optik M abgeblendet</b> with optic M deglared		CU011227	288,53 €		
	<b>Glas M klar, Reflektor zylindrisch</b> glass M clear, reflector cylindrical			<b>mit Optik M abgeblendet</b> with optic M deglared		CU011228			
	<b>Glas M opal</b> glass M opal			<b>mit Optik M abgeblendet</b> with optic M deglared		CU011242	247,31 €		
	<b>Glas M neusilber</b> glass M new silver			<b>mit Optik M verspiegelt</b> with optic M mirrored		CU011246	384,70 €		
	<b>Acrylglas M klar</b> acrylic glass M clear			<b>mit Optik M abgeblendet</b> with optic M deglared		CU011223	146,55 €		
	<b>Acrylglas M klar, Reflektor konisch</b> acrylic glass M clear, reflector conical			<b>mit Optik M abgeblendet</b> with optic M deglared		CU011234	174,03 €		
	<b>Acrylglas M klar, Reflektor zylindrisch</b> acrylic glass M clear, reflector cylindrical			<b>mit Optik M abgeblendet</b> with optic M deglared		CU011235			







 modular article  
  IP40 protection class  
  through wiring  
  emergency light option  
  battery option

LED  
  dimmable  
  Zhaga standard  
  dim2warm  
  CRI >97  
  SDCM 2

## CURLING Optik/optic M new



Abbildung figure	Beschreibung description	Art.-Nr. art.-no.	€ netto CH excl. VAT
	<b>Optik M/L up/down, Aluminium weiß lackiert</b> optic M/L up/down, aluminium white painted	CU8544	50,38 €
	<b>Optik M verspiegelt</b> optic M mirrored	CU8561	43,97 €

## CURLING Wall L new

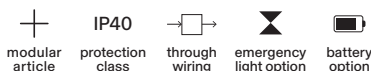
Abbildung figure	Beschreibung description	Regelung control	Leistung power	CCT	EEK EEC	Lumen lumen	Art.-Nr. art.-no.	€ netto CH excl. VAT	
	<b>LIGHT ENGINE</b> Ceiling/Wall L	TRIAC	34 W	2700 K	F	3300 lm	LE014480	329,75 €	
				3000 K	F	3450 lm	LE014483		
				4000 K <span style="color: #0070C0;">new</span>	F	3570 lm	LE015762		
		DALI	34 W	3000 K	3000 K	F	3450 lm	LE014481	357,23 €
						F	3570 lm	LE015763	
						F	3300 lm	LE014480C	
		CASAMBI <span style="color: #0070C0;">new</span>	34 W	3000 K	3000 K	F	3450 lm	LE014483C	421,34 €
						F	3570 lm	LE015763C	
						F	3300 lm	LE014480C	
	<b>Glas L klar</b> glass L clear			<b>mit Optik L abgeblendet</b> with optic L deglared			CU011210	384,70 €	
	<b>Glas L klar, Reflektor konisch</b> glass L clear, reflector conical			<b>mit Optik L abgeblendet</b> with optic L deglared			CU011230	393,86 €	
	<b>Glas L klar, Reflektor zylindrisch</b> glass L clear, reflector cylindrical			<b>mit Optik L abgeblendet</b> with optic L deglared			CU011231	380,13 €	
	<b>Glas L opal</b> glass L opal			<b>mit Optik M abgeblendet</b> with optic M deglared			CU011243	485,46 €	
	<b>Glas L neusilber</b> glass L new silver			<b>mit Optik L verspiegelt</b> with optic L mirrored			CU011247		





## CURLING Optik/optic L new

Abbildung figure	Beschreibung description	Art.-Nr. art.-no.	€ netto CH excl. VAT
	<b>Optik M/L up/down, Aluminium weiß lackiert</b> optic M/L up/down, aluminium white painted	für alle Versionen geeignet suitable for all versions	CU8544 50,38 €
	<b>Optik L verspiegelt</b> optic L mirrored	für alle Versionen geeignet suitable for all versions	CU8562 52,21 €

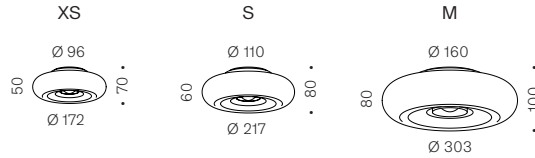
# DON Ceiling new



## DON Ceiling XS new



Abbildung figure	Beschreibung description	Regelung control	Leistung power	CCT	EELCC	Lumen lumen	Art.-Nr. art.-no.	€ netto CH excl. VAT
 <span style="background-color: #0070C0; color: white; padding: 2px;">new</span>	<b>LIGHT ENGINE</b> Ceiling/Wall XS	TRIAC	8 W	2700 K	E	690 lm	LE015750	141,97 €
				3000 K	E	710 lm	LE015751	
		DALI	8 W	2700 K	E	690 lm	LE015753	164,87 €
				3000 K	E	710 lm	LE015754	
CASAMBI	8 W	2700 K	E	690 lm	LE015753C	233,58 €		
		3000 K	E	710 lm	LE015754C			
 <span style="background-color: #0070C0; color: white; padding: 2px;">new</span>	<b>Glas XS klar</b> glass XS clear	<b>Optik XS Glaslinse eng 40°, Fassung Aluminium poliert</b> optic XS glass lens narrow 40°, socket aluminium polished					DO1001	174,03 €
		<b>Optik XS Glaslinse weit 55°, Fassung Aluminium poliert</b> optic XS glass lens wide 55°, socket aluminium polished					DO1002	
 <span style="background-color: #0070C0; color: white; padding: 2px;">new</span>	<b>Glas XS neusilber</b> glass XS new silver	<b>Optik XS Glaslinse eng 40°, Fassung Aluminium poliert</b> optic XS glass lens narrow 40°, socket aluminium polished					DO1011	228,99 €
		<b>Optik XS Glaslinse weit 55°, Fassung Aluminium poliert</b> optic XS glass lens wide 55°, socket aluminium polished					DO1012	



## DON Optik/optic XS new

Abbildung figure	Beschreibung description	Art.-Nr. art.-no.	€ netto CH excl. VAT
 <span style="background-color: #0070C0; color: white; padding: 2px;">new</span>	<b>Optik XS Microprismatik Kegelkuppen 60° entblendet</b> optic XS microprismatic cone domes 60° glare-free	<b>für alle Versionen geeignet</b> suitable for all versions	CU8557 23,82 €
 <span style="background-color: #0070C0; color: white; padding: 2px;">new</span>	<b>Optik XS abgeblendet</b> optic XS deglared	<b>für alle Versionen geeignet</b> suitable for all versions	CU8547 20,15 €
 <span style="background-color: #0070C0; color: white; padding: 2px;">new</span>	<b>Optik XS verspiegelt</b> optic XS mirrored	<b>für alle Versionen geeignet</b> suitable for all versions	CU8559 20,15 €

## DON Ceiling S new

Abbildung figure	Beschreibung description	Regelung control	Leistung power	CCT	EEK EEC	Lumen lumen	Art.-Nr. art.-no.	€ netto CH excl. VAT			
	<b>LIGHT ENGINE</b> Ceiling/Wall S	TRIAC	11 W	2700 K	E	1170 lm	LE015701	206,10 €			
				3000 K	E	1230 lm	LE015702				
				4000 K <span style="color: #0070C0;">new</span>	E	1280 lm	LE015733				
				1800-3000 K dim2warm	F	870 lm	LE015703		247,31 €		
				2700 K	E	1170 lm	LE015730		233,58 €		
				3000 K	E	1230 lm	LE015731				
		4000 K <span style="color: #0070C0;">new</span>	E	1280 lm	LE015734						
		DALI	11 W	1800-3000 K dim2warm	F	870 lm	LE015732	274,79 €			
					CASAMBI <span style="color: #0070C0;">new</span>	11 W	2700 K	E	1170 lm	LE015701C	297,69 €
							3000 K	E	1230 lm	LE015702C	
							4000 K	E	1280 lm	LE015733C	
							1800-3000 K dim2warm	F	870 lm	LE015703C	
	<b>Glas S klar</b> glass S clear				<b>Optik S Glaslinse eng 32°, Fassung Aluminium poliert</b> optic S glass lens narrow 32°, socket aluminium polished					DO1031	219,83 €
		<b>Optik S Glaslinse weit 59°, Fassung Aluminium poliert</b> optic S glass lens wide 59°, socket aluminium polished					DO1032				
	<b>Glas S neusilber</b> glass S new silver	<b>Optik S Glaslinse eng 32°, Fassung Aluminium poliert</b> optic S glass lens narrow 32°, socket aluminium polished					DO1041	293,11 €			
		<b>Optik S Glaslinse weit 59°, Fassung Aluminium poliert</b> optic S glass lens wide 59°, socket aluminium polished					DO1042				



 modular article  
 IP40 protection class  
 through wiring





 LED  
 dimmable  
 Zhaga standard  
 dim2warm  
 CRI >97  
 SDCM 2

## DON Optik/optic S new

Abbildung figure	Beschreibung description	Art.-Nr. art.-no.	€ netto CH excl. VAT
	<b>Optik S Microprismatik Kegelkuppen 60° entblendet</b> optic S microprismatic cone domes 60° glare-free	für alle Versionen geeignet suitable for all versions	CU8539 27,48 €
	<b>Optik S abgeblendet</b> optic S deglared	für alle Versionen geeignet suitable for all versions	CU8532 22,90 €
	<b>Optik S verspiegelt</b> optic S mirrored	für alle Versionen geeignet suitable for all versions	CU8560 27,48 €



## DON Ceiling M new

Abbildung figure	Beschreibung description	Regelung control	Leistung power	CCT	EЕК EEC	Lumen lumen	Art.-Nr. art.-no.	€ netto CH excl. VAT	
	<b>LIGHT ENGINE</b> Ceiling/Wall M	TRIAC	20 W	2700 K	F	1910 lm	LE015710	274,79 €	
				3000 K	E	2010 lm	LE015711		
				4000 K <span style="color: #0070C0;">new</span>	E	2080 lm	LE015770		
				1800-3000 K dim2warm	F	1540 lm	LE015712		274,79 €
				2700 K	F	1910 lm	LE015713		302,27 €
				3000 K	E	2010 lm	LE015714		
		DALI	20 W	4000 K <span style="color: #0070C0;">new</span>	E	2080 lm	LE015771	338,90 €	
				1800-3000 K dim2warm	F	1540 lm	LE015715		
				2700 K	F	1910 lm	LE015713C		393,86 €
				3000 K	E	2010 lm	LE015714C		
				4000 K	E	2080 lm	LE015770C		
				1800-3000 K dim2warm	F	1540 lm	LE015715C		
	<b>Glas M klar</b> glass M clear	<b>Optik M Glaslinse eng 35°, Fassung Aluminium poliert</b> optic M glass lens narrow 35°, socket aluminium polished					DO1061	265,63 €	
		<b>Optik M Glaslinse weit 48°, Fassung Aluminium poliert</b> optic M glass lens wide 48°, socket aluminium polished					DO1062		
	<b>Glas M neusilber</b> glass M new silver	<b>Optik M Glaslinse eng 35°, Fassung Aluminium poliert</b> optic M glass lens narrow 35°, socket aluminium polished					DO1071	357,23 €	
		<b>Optik M Glaslinse weit 48°, Fassung Aluminium poliert</b> optic M glass lens wide 48°, socket aluminium polished					DO1072		

 modular article  
 IP40 protection class  
 through wiring  
 emergency light option  
 battery option

LED  dimmable  Zhaga standard  dim2warm  CRI >97  SDCM 2

## DON Optik/optic M new

Abbildung figure	Beschreibung description	Art.-Nr. art.-no.	€ netto CH excl. VAT
	<b>Optik M Microprismatik Kegelkuppen 60° entblendet</b> optic M microprismatic cone domes 60° glare-free	für alle Versionen geeignet suitable for all versions	CU8536 43,97 €
	<b>Optik M abgeblendet</b> optic M deglared	für alle Versionen geeignet suitable for all versions	CU8535 38,47 €
	<b>Optik M verspiegelt</b> optic M mirrored	für alle Versionen geeignet suitable for all versions	CU8561 43,97 €

## Rope

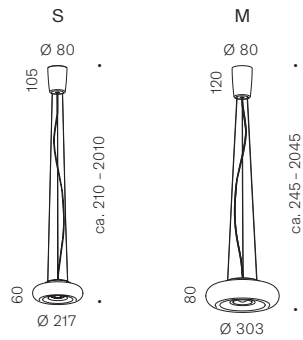



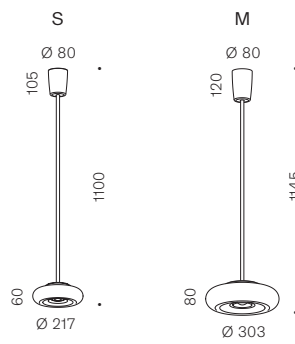

## Tube



Winkeladapter für Dachschrägen in weiß erhältlich – Montagehilfe für einfache Installation.  
 Der Winkel kann individuell angefertigt werden – Sonderfarben auf Anfrage.  
 Bestellungen (Art.-Nr.: ZB1012) bitte in Abstimmung mit dem Vertrieb.  
 Angle brackets for sloping roofs available in white – to assist with easy installation.  
 The brackets can be made to measure – special colours available on request.  
 Please coordinate orders (art.-no.: ZB1012) with the sales department.

## DON Suspension S new

Abbildung figure	Beschreibung description	Regelung control	Leistung power	CCT	EK EEC	Lumen lumen	Art.-Nr. art.-no.	€ netto CH excl. VAT
	<b>LIGHT ENGINE</b> Suspension Rope S	TRIAC	11 W	2700 K	E	1170 lm	LE015704	403,03 €
				3000 K	E	1230 lm	LE015705	
				4000 K <span style="color: #0070C0;">new</span>	E	1280 lm	LE015738	
				1800-3000 K dim2warm	F	870 lm	LE015706	
		DALI	11 W	2700 K	E	1170 lm	LE015735	435,08 €
				3000 K	E	1230 lm	LE015736	
				4000 K <span style="color: #0070C0;">new</span>	E	1280 lm	LE015739	
				1800-3000 K dim2warm	F	870 lm	LE015737	
		CASAMBI <span style="color: #0070C0;">new</span>	11 W	2700 K	E	1170 lm	LE015704C	494,62 €
				3000 K	E	1230 lm	LE015736C	
				4000 K	E	1280 lm	LE015738C	
				1800-3000 K dim2warm	F	870 lm	LE015737C	
	<b>LIGHT ENGINE</b> Suspension Tube S	TRIAC	11 W	2700 K	E	1170 lm	LE015707	357,23 €
				3000 K	E	1230 lm	LE015708	
				4000 K <span style="color: #0070C0;">new</span>	E	1280 lm	LE015743	
				1800-3000 K dim2warm	F	870 lm	LE015709	
		DALI	11 W	2700 K	E	1170 lm	LE015740	393,86 €
				3000 K	E	1230 lm	LE015741	
				4000 K <span style="color: #0070C0;">new</span>	E	1280 lm	LE015744	
				1800-3000 K dim2warm	F	870 lm	LE015742	
		CASAMBI <span style="color: #0070C0;">new</span>	11 W	2700 K	E	1170 lm	LE015740C	448,82 €
				3000 K	E	1230 lm	LE015741C	
				4000 K	E	1280 lm	LE015743C	
				1800-3000 K dim2warm	F	870 lm	LE015742C	
	<b>Glas S klar</b> glass S clear	<b>Optik S Glaslinse eng 32°, Fassung Aluminium poliert</b> optic S glass lens narrow 32°, socket aluminium polished					DO1031	219,83 €
		<b>Optik S Glaslinse weit 59°, Fassung Aluminium poliert</b> optic S glass lens wide 59°, socket aluminium polished					DO1032	
	<b>Glas S neusilber</b> glass S new silver	<b>Optik S Glaslinse eng 32°, Fassung Aluminium poliert</b> optic S glass lens narrow 32°, socket aluminium polished					DO1041	293,11 €
		<b>Optik S Glaslinse weit 59°, Fassung Aluminium poliert</b> optic S glass lens wide 59°, socket aluminium polished					DO1042	





 modular article  
 IP20 protection class  
 through wiring  
 tube cuttable  
 + length option







LED  dimmable  Zhaga standard  dim2warm  CRI >97  SDCM 3

## DON Optik/optic S new

Abbildung figure	Beschreibung description	Art.-Nr. art.-no.	€ netto CH excl. VAT
	<b>Optik S Microprismatik Kegelkuppen 60° entblendet</b> optic S microprismatic cone domes 60° glare-free	<b>für alle Versionen geeignet</b> suitable for all versions	CU8539 27,48 €

## DON Suspension M new

Abbildung figure	Beschreibung description	Regelung control	Leistung power	CCT	EEK EEC	Lumen lumen	Art.-Nr. art.-no.	€ netto CH excl. VAT		
	<b>LIGHT ENGINE</b> Suspension Rope M	TRIAC	27 W	2700 K	F	1910 lm	LE015716	485,46 €		
				3000 K	E	2010 lm	LE015717			
				4000 K <span style="color: #0070C0;">new</span>	E	2080 lm	LE015772			
				1800-3000 K dim2warm	F	1540 lm	LE015718		526,68 €	
				2700 K	F	1910 lm	LE015719		517,52 €	
				3000 K	E	2010 lm	LE015720			
		4000 K <span style="color: #0070C0;">new</span>	E	2080 lm	LE015773					
		CASAMBI <span style="color: #0070C0;">new</span>	27 W	DALI	27 W	1800-3000 K dim2warm	F	1540 lm	LE015721	558,74 €
						2700 K	F	1910 lm	LE015716C	572,48 €
						3000 K	E	2010 lm	LE015720C	
						4000 K	E	2080 lm	LE015773C	
						1800-3000 K dim2warm	F	1540 lm	LE015718C	618,28 €
	<b>LIGHT ENGINE</b> Suspension Tube M					TRIAC	27 W	2700 K	F	1910 lm
		3000 K	E	2010 lm	LE015723					
		4000 K <span style="color: #0070C0;">new</span>	E	2080 lm	LE015728					
		1800-3000 K dim2warm	F	1540 lm	LE015724			476,30 €		
		2700 K	F	1910 lm	LE015725			467,14 €		
		3000 K	E	2010 lm	LE015726					
		4000 K <span style="color: #0070C0;">new</span>	E	2080 lm	LE015729					
		CASAMBI <span style="color: #0070C0;">new</span>	27 W	DALI	27 W	1800-3000 K dim2warm	F	1540 lm	LE015727	512,94 €
						2700 K	F	1910 lm	LE015722C	517,52 €
						3000 K	E	2010 lm	LE015723C	
						4000 K	E	2080 lm	LE015729C	
						1800-3000 K dim2warm	F	1540 lm	LE015724C	549,58 €
	<b>Glas M klar</b> glass M clear					<b>Optik M Glaslinse eng 35°, Fassung Aluminium poliert</b> optic M glass lens narrow 35°, socket aluminium polished				
		<b>Optik M Glaslinse weit 48°, Fassung Aluminium poliert</b> optic M glass lens wide 48°, socket aluminium polished					DO1062			
	<b>Glas M neusilber</b> glass M new silver	<b>Optik M Glaslinse eng 35°, Fassung Aluminium poliert</b> optic M glass lens narrow 35°, socket aluminium polished					DO1071	357,23 €		
		<b>Optik M Glaslinse weit 48°, Fassung Aluminium poliert</b> optic M glass lens wide 48°, socket aluminium polished					DO1072			

 modular article  
  IP20 protection class  
  through wiring  
  tube cuttable  
  + length option  
  emergency light option

LED  
  dimmable  
  Zhaga standard  
  dim2warm  
  CRI >97  
  SDCM 3



## DON Optik/optic M new

Abbildung figure	Beschreibung description	Art.-Nr. art.-no.	€ netto CH excl. VAT
	<b>Optik M Microprismatik Kegelkuppen 60° entblendet</b> optic M microprismatic cone domes 60° glare-free	für alle Versionen geeignet suitable for all versions	CU8536 43,97 €

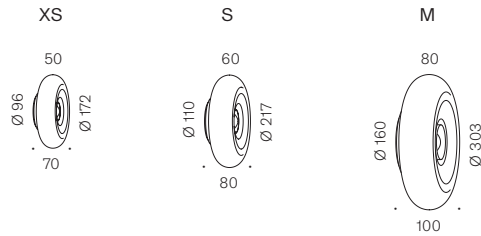
# DON Wall new



## DON Wall XS new

Abbildung figure	Beschreibung description	Regelung control	Leistung power	CCT	EEL EEC	Lumen lumen	Art.-Nr. art.-no.	€ netto CH excl. VAT
 <span style="background-color: #0070C0; color: white; padding: 2px;">new</span>	<b>LIGHT ENGINE</b> Ceiling/Wall XS	TRIAC	8 W	2700 K	E	690 lm	LE015750	141,97 €
				3000 K	E	710 lm	LE015751	
		DALI	8 W	2700 K	E	690 lm	LE015753	164,87 €
				3000 K	E	710 lm	LE015754	
		CASAMBI	8 W	2700 K	E	690 lm	LE015753C	233,58 €
				3000 K	E	710 lm	LE015754C	
 <span style="background-color: #0070C0; color: white; padding: 2px;">new</span>	<b>Glas XS klar</b> glass XS clear	Optik XS Spiegel optic XS mirror					DO1021	146,55 €
 <span style="background-color: #0070C0; color: white; padding: 2px;">new</span>	<b>Glas XS neusilber</b> glass XS new silver	Optik XS Spiegel optic XS mirror					DO1022	201,51 €

 modular article  
 IP44 protection class  
 through wiring

 LED  
 dimmable  
 Zhaga standard  
 CRI >97  
 SDCM 2



## DON Optik/optic XS new

Abbildung figure	Beschreibung description	Art.-Nr. art.-no.	€ netto CH excl. VAT
 <span style="background-color: #0070C0; color: white; padding: 2px;">new</span>	<b>Optik XS abgeblendet</b> optic XS deglared	für alle Versionen geeignet suitable for all versions	CU8547
			20,15 €

## DON Optik/optic S new

Abbildung figure	Beschreibung description	Art.-Nr. art.-no.	€ netto CH excl. VAT
 <span style="background-color: #0070C0; color: white; padding: 2px;">new</span>	<b>Optik S abgeblendet</b> optic S deglared	für alle Versionen geeignet suitable for all versions	CU8532
			27,48 €



## DON Wall S new





Abbildung figure	Beschreibung description	Regelung control	Leistung power	CCT	EEK EEC	Lumen lumen	Art.-Nr. art.-no.	€ netto CH excl. VAT	
	<b>LIGHT ENGINE</b> Ceiling/Wall S	TRIAC	11 W	2700 K	E	1170 lm	LE015701	206,10 €	
				3000 K	E	1230 lm	LE015702		
				4000 K <span style="color: #0070C0;">new</span>	E	1280 lm	LE015733		
				1800-3000 K dim2warm	F	870 lm	LE015703		247,31 €
				2700 K	E	1170 lm	LE015730		233,58 €
				3000 K	E	1230 lm	LE015731		
		4000 K <span style="color: #0070C0;">new</span>	E	1280 lm	LE015734				
		CASAMBI <span style="color: #0070C0;">new</span>	11 W		1800-3000 K dim2warm	F	870 lm	LE015732	274,79 €
					2700 K	E	1170 lm	LE015701C	297,69 €
					3000 K	E	1230 lm	LE015702C	
		4000 K	E	1280 lm	LE015733C				
					1800-3000 K dim2warm	F	870 lm	LE015703C	343,49 €
	<b>Glas S klar</b> glass S clear	Optik S Spiegel optic S mirror					DO1051	196,93 €	
	<b>Glas S neusilber</b> glass S new silver	Optik S Spiegel optic S mirror					DO1052	261,06 €	

 IP40  
modular article protection class

LED       
dimmable Zhaga standard dim2warm CRI >97 SDCM 2

## DON Wall M new

Abbildung figure	Beschreibung description	Regelung control	Leistung power	CCT	EEK EEC	Lumen lumen	Art.-Nr. art.-no.	€ netto CH excl. VAT	
	<b>LIGHT ENGINE</b> Ceiling/Wall M	TRIAC	20 W	2700 K	F	1910 lm	LE015710	274,79 €	
				3000 K	E	2010 lm	LE015711		
				4000 K <span style="color: #0070C0;">new</span>	E	2080 lm	LE015770		
				1800-3000 K dim2warm	F	1540 lm	LE015712		274,79 €
				2700 K	F	1910 lm	LE015713		302,27 €
				3000 K	E	2010 lm	LE015714		
		4000 K <span style="color: #0070C0;">new</span>	E	2080 lm	LE015771				
		CASAMBI <span style="color: #0070C0;">new</span>	20 W		1800-3000 K dim2warm	F	1540 lm	LE015715	338,90 €
					2700 K	F	1910 lm	LE015713C	393,86 €
					3000 K	E	2010 lm	LE015714C	
		4000 K	E	2080 lm	LE015770C				
					1800-3000 K dim2warm	F	1540 lm	LE015715C	430,51 €
	<b>Glas M klar</b> glass M clear	Optik M Spiegel optic M mirror					DO1081	247,31 €	
	<b>Glas M neusilber</b> glass M new silver	Optik M Spiegel optic M mirror					DO1082	329,75 €	

 IP40     
modular article protection class through wiring emergency light option battery option

LED       
dimmable Zhaga standard dim2warm CRI >97 SDCM 2





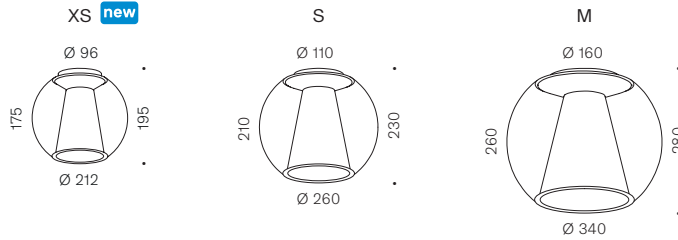

## DON Optik/optic M new

Abbildung figure	Beschreibung description	Art.-Nr. art.-no.	€ netto CH excl. VAT
	<b>Optik M/L up/down, Aluminium weiß lackiert</b> optic M/L up/down, aluminium white painted	für alle Versionen geeignet suitable for all versions	CU8544 50,38 €

# DRAFT Ceiling



## DRAFT Ceiling XS new

Abbildung figure	Beschreibung description	Regelung control	Leistung power	CCT	EEL EEC	Lumen lumen	Art.-Nr. art.-no.	€ netto CH excl. VAT
	<b>LIGHT ENGINE</b> Ceiling/Wall XS	TRIAC	8 W	2700 K	E	720lm	LE015750	141,97 €
				3000 K	E	760lm	LE015751	
		DALI	8 W	2700 K	E	720lm	LE015753	164,87 €
				3000 K	E	760lm	LE015754	
		CASAMBI	8 W	2700 K	E	720lm	LE015753C	233,58 €
				3000 K	E	760lm	LE015754C	
	 <b>Glas XS klar mit Reflektor</b> glass XS clear with reflector						DR015720	187,77 €
	 <b>Glas XS braun mit Reflektor</b> glass XS brown with reflector						DR015721	219,83 €
	 <b>Glas XS blau mit Reflektor</b> glass XS blue with reflector						DR015722	

 modular article
  IP40 protection class
  through wiring

LED
  dimmable
  Zhaga standard
  CRI > 97
  SDCM 2

# DRAFT Ceiling S new

Abbildung figure	Beschreibung description	Regelung control	Leistung power	CCT	EEK EEC	Lumen lumen	Art.-Nr. art.-no.	€ netto CH excl. VAT	
	<b>LIGHT ENGINE</b> Ceiling/Wall S	TRIAC	11 W	2700 K	E	1170 lm	LE015701	206,10 €	
				3000 K	E	1230 lm	LE015702		
				4000 K <span style="color: #0070C0;">new</span>	E	1280 lm	LE015733		
				1800-3000 K dim2warm	F	870 lm	LE015703		247,31 €
				2700 K	E	1170 lm	LE015730		233,58 €
				3000 K	E	1230 lm	LE015731		
		4000 K <span style="color: #0070C0;">new</span>	E	1280 lm	LE015734				
		CASAMBI <span style="color: #0070C0;">new</span>	11 W		1800-3000 K dim2warm	F	870 lm	LE015732	274,79 €
					2700 K	E	1170 lm	LE015701C	297,69 €
					3000 K	E	1230 lm	LE015702C	
					4000 K	E	1280 lm	LE015733C	
					1800-3000 K dim2warm	F	870 lm	LE015703C	

	<b>Glas S klar mit Reflektor</b> glass S clear with reflector						DR015728	283,95 €
---	--	--	--	--	--	--	----------	----------

	<b>Glas S braun mit Reflektor</b> glass S brown with reflector						DR015729	
---	---	--	--	--	--	--	----------	--

	<b>Glas S blau mit Reflektor</b> glass S blue with reflector						DR015730	325,17 €
---	---	--	--	--	--	--	----------	----------

 modular article  
 IP40 protection class  
 through wiring

 LED  
 dimmable  
 Zhaga standard  
 dim2warm  
 CRI > 97  
 SDCM 2





# DRAFT Ceiling M new

Abbildung figure	Beschreibung description	Regelung control	Leistung power	CCT	EЕК EEC	Lumen lumen	Art.-Nr. art.-no.	€ netto CH excl. VAT
	<b>LIGHT ENGINE</b> Ceiling/Wall M	TRIAC	20 W	2700 K	F	1910 lm	LE015710	274,79 €
				3000 K	E	2010 lm	LE015711	
				4000 K <span style="color: #0070C0;">new</span>	E	2080 lm	LE015770	
				1800-3000 K dim2warm	F	1540 lm	LE015712	
		DALI	20 W	2700 K	F	1910 lm	LE015713	302,27 €
				3000 K	E	2010 lm	LE015714	
				4000 K <span style="color: #0070C0;">new</span>	E	2080 lm	LE015771	
		CASAMBI <span style="color: #0070C0;">new</span>	20 W	1800-3000 K dim2warm	F	1540 lm	LE015715	338,90 €
				2700 K	F	1910 lm	LE015713C	393,86 €
				3000 K	E	2010 lm	LE015714C	
				4000 K	E	2080 lm	LE015770C	
		1800-3000 K dim2warm	F	1540 lm	LE015715C	430,51 €		

	<b>Glas M klar mit Reflektor</b> glass M clear with reflector						DR015731	375,55 €
---	--	--	--	--	--	--	----------	----------

	<b>Glas M braun mit Reflektor</b> glass M brown with reflector						DR015732	
---	---	--	--	--	--	--	----------	--

	<b>Glas M blau mit Reflektor</b> glass M blue with reflector						DR015733	425,93 €
---	---	--	--	--	--	--	----------	----------





-  modular article
-  IP40 protection class
-  through wiring
-  emergency light option
-  battery option

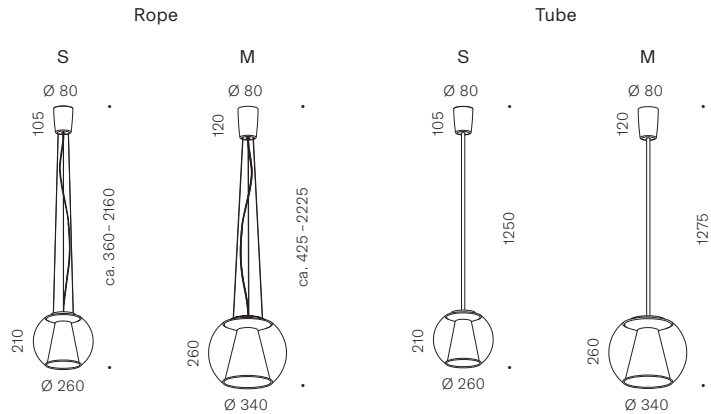



-  LED
-  dimmable
-  Zhaga standard
-  dim2warm
-  CRI >97
-  SDCM 2

# DRAFT Suspension







## DRAFT Suspension S new





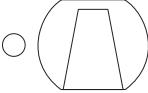
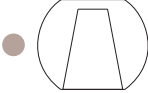

Abbildung figure	Beschreibung description	Regelung control	Leistung power	CCT	EEL EEC	Lumen lumen	Art.-Nr. art.-no.	€ netto CH excl. VAT		
	<b>LIGHT ENGINE</b> Suspension Rope S	TRIAC	11 W	2700K	E	1170 lm	LE015704	403,03 €		
				3000K	E	1230 lm	LE015705			
				4000K <span style="background-color: #0070C0; color: white; padding: 2px;">new</span>	E	1280 lm	LE015738			
				1800-3000K dim2warm	F	870 lm	LE015706		435,08 €	
				2700K	E	1170 lm	LE015735		435,08 €	
				3000K	E	1230 lm	LE015736			
		4000K <span style="background-color: #0070C0; color: white; padding: 2px;">new</span>	E	1280 lm	LE015739					
		DALI	11 W	1800-3000K dim2warm	F	870 lm	LE015737	467,14 €		
				CASAMBI <span style="background-color: #0070C0; color: white; padding: 2px;">new</span>	11 W	2700K	E	1170 lm	LE015704C	494,62 €
						3000K	E	1230 lm	LE015736C	
		4000K	E			1280 lm	LE015738C			
			<b>LIGHT ENGINE</b> Suspension Tube S	TRIAC	11 W	2700K	E	1170 lm	LE015707	357,23 €
3000K	E					1230 lm	LE015708			
4000K <span style="background-color: #0070C0; color: white; padding: 2px;">new</span>	E					1280 lm	LE015743			
1800-3000K dim2warm	F					870 lm	LE015709	393,86 €		
2700K	E					1170 lm	LE015740	393,86 €		
3000K	E					1230 lm	LE015741			
4000K <span style="background-color: #0070C0; color: white; padding: 2px;">new</span>	E			1280 lm	LE015744					
DALI	11 W			1800-3000K dim2warm	F	870 lm	LE015742	425,93 €		
				CASAMBI <span style="background-color: #0070C0; color: white; padding: 2px;">new</span>	11 W	2700K	E	1170 lm	LE015740C	448,82 €
						3000K	E	1230 lm	LE015741C	
4000K	E					1280 lm	LE015743C			
CASAMBI <span style="background-color: #0070C0; color: white; padding: 2px;">new</span>	11 W			1800-3000K dim2warm	F	870 lm	LE015742C	485,46 €		
				Glas S klar mit Reflektor glass S clear with reflector			DR015728	283,95 €		
						Glas S braun mit Reflektor glass S brown with reflector			DR015729	325,17 €
Glas S blau mit Reflektor glass S blue with reflector							DR015730			

-  modular article
-  IP20 protection class
-  through wiring
-  tube cuttable
-  + length option

-  LED
-  dimmable
-  Zhaga standard
-  dim2warm
-  CRI > 97
-  SDCM 3

## DRAFT Suspension M new

Abbildung figure	Beschreibung description	Regelung control	Leistung power	CCT	EK EEC	Lumen lumen	Art.-Nr. art.-no.	€ netto CH excl. VAT		
	<b>LIGHT ENGINE</b> Suspension Rope M	TRIAC	27 W	2700 K	F	1910 lm	LE015716	485,46 €		
				3000 K	E	2010 lm	LE015717			
				4000 K <span style="color: #0070C0;">new</span>	E	2080 lm	LE015772			
				1800-3000 K dim2warm	F	1540 lm	LE015718		526,68 €	
				2700 K	F	1910 lm	LE015719		517,52 €	
				3000 K	E	2010 lm	LE015720			
		4000 K <span style="color: #0070C0;">new</span>	E	2080 lm	LE015773					
		CASAMBI <span style="color: #0070C0;">new</span>	27 W			1800-3000 K dim2warm	F	1540 lm	LE015721	558,74 €
						2700 K	F	1910 lm	LE015716C	572,48 €
						3000 K	E	2010 lm	LE015720C	
						4000 K	E	2080 lm	LE015773C	
						1800-3000 K dim2warm	F	1540 lm	LE015718C	618,28 €
	<b>LIGHT ENGINE</b> Suspension Tube M					TRIAC	27 W	2700 K	F	1910 lm
		3000 K	E	2010 lm	LE015723					
		4000 K <span style="color: #0070C0;">new</span>	E	2080 lm	LE015728					
		1800-3000 K dim2warm	F	1540 lm	LE015724			476,30 €		
		2700 K	F	1910 lm	LE015725			467,14 €		
		3000 K	E	2010 lm	LE015726					
		4000 K <span style="color: #0070C0;">new</span>	E	2080 lm	LE015729					
		CASAMBI <span style="color: #0070C0;">new</span>	27 W			1800-3000 K dim2warm	F	1540 lm	LE015727	512,94 €
						2700 K	F	1910 lm	LE015722C	517,52 €
						3000 K	E	2010 lm	LE015723C	
						4000 K	E	2080 lm	LE015729C	
						1800-3000 K dim2warm	F	1540 lm	LE015724C	549,58 €
	<b>Glas M klar mit Reflektor</b> glass M clear with reflector									
	<b>Glas M braun mit Reflektor</b> glass M brown with reflector						DR015732	425,93 €		
	<b>Glas M blau mit Reflektor</b> glass M blue with reflector						DR015733			

 modular article  
  IP20 protection class  
  through wiring  
  tube cuttable  
  + length option  
  emergency light option

LED  
  dimmable  
  Zhaga standard  
  dim2warm  
  CRI >97  
  SDCM 3

**Winkeladapter für Dachschrägen in weiß erhältlich – Montagehilfe für einfache Installation.**

**Der Winkel kann individuell angefertigt werden – Sonderfarben auf Anfrage.**

**Bestellungen (Art.-Nr.: ZB1012) bitte in Abstimmung mit dem Vertrieb.**

Angle brackets for sloping roofs available in white – to assist with easy installation.

The brackets can be made to measure – special colours available on request.

Please coordinate orders (art.-no.: ZB1012) with the sales department.



# DRUM Ceiling

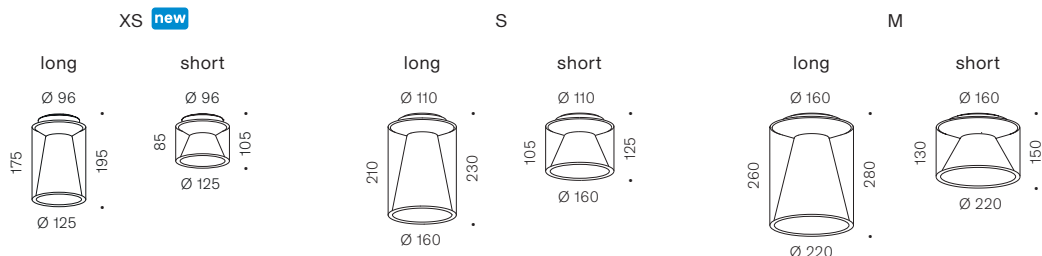



**Black Edition – Leuchtenkörper und Innenschirm in mattem Schwarz – für eine besonders eindrucksvolle, magische Lichtwirkung.**

**Bei Fragen zur Sonderedition wenden Sie sich bitte an den Vertrieb.**

Black Edition – Lamp body and inner shade in matt black – for a particularly striking, magical lighting effect.

If you have any questions about the special edition, please contact our sales department.

## DRUM Ceiling XS new

Abbildung figure	Beschreibung description	Regelung control	Leistung power	CCT	EEK EEC	Lumen lumen	Art.-Nr. art.-no.	€ netto CH excl. VAT
 <b>new</b>	<b>LIGHT ENGINE</b> Ceiling/Wall XS	TRIAC	8 W	2700 K	E	720 lm	LE015750	141,97 €
				3000 K	E	760 lm	LE015751	
		DALI	8 W	2700 K	E	720 lm	LE015753	164,87 €
				3000 K	E	760 lm	LE015754	
		CASAMBI	8 W	2700 K	E	720 lm	LE015753C	233,58 €
				3000 K	E	760 lm	LE015754C	
 <b>new</b>	<b>Glas XS long mit Reflektor</b> glass XS long with reflector						DU015806	178,62 €
 <b>new</b>	<b>Glas XS short mit Reflektor</b> glass XS short with reflector						DU015805	137,39 €

+ IP40  
modular protection  
article class

LED



 dimmable

 Zhaga  
standard

 CRI >97

 SDCM 2

## DRUM Ceiling S new



Abbildung figure	Beschreibung description	Regelung control	Leistung power	CCT	EEL EEC	Lumen lumen	Art.-Nr. art.-no.	€ netto CH excl. VAT
	<b>LIGHT ENGINE</b> Ceiling/Wall S	TRIAC	11 W	2700 K	E	1170 lm	LE015701	206,10 €
				3000 K	E	1230 lm	LE015702	
				4000 K <span style="color: #0070C0;">new</span>	E	1280 lm	LE015733	
				1800-3000 K dim2warm	F	870 lm	LE015703	
		DALI	11 W	2700 K	E	1170 lm	LE015730	233,58 €
				3000 K	E	1230 lm	LE015731	
				4000 K <span style="color: #0070C0;">new</span>	E	1280 lm	LE015734	
				1800-3000 K dim2warm	F	870 lm	LE015732	
		CASAMBI <span style="color: #0070C0;">new</span>	11 W	2700 K	E	1170 lm	LE015701C	297,69 €
				3000 K	E	1230 lm	LE015702C	
				4000 K	E	1280 lm	LE015733C	
				1800-3000 K dim2warm	F	870 lm	LE015703C	
	<b>Glas S long mit Reflektor</b> glass S long with reflector						DU015801	215,25 €

	<b>Glas S short mit Reflektor</b> glass S short with reflector						DU015802	164,87 €
---	---	--	--	--	--	--	----------	----------



 IP40  
modular protection  
article class

LED     

## DRUM Ceiling M new

Abbildung figure	Beschreibung description	Regelung control	Leistung power	CCT	Lu- men lumen	EEL EEC	Art.-Nr. art.-no.	€ netto CH excl. VAT
	<b>LIGHT ENGINE</b> Ceiling/Wall M	TRIAC	20 W	2700 K	F	1910 lm	LE015710	274,79 €
				3000 K	E	2010 lm	LE015711	
				4000 K <span style="color: #0070C0;">new</span>	E	2080 lm	LE015770	
				1800-3000 K dim2warm	F	1540 lm	LE015712	
		DALI	20 W	2700 K	F	1910 lm	LE015713	302,27 €
				3000 K	E	2010 lm	LE015714	
				4000 K <span style="color: #0070C0;">new</span>	E	2080 lm	LE015771	
				1800-3000 K dim2warm	F	1540 lm	LE015715	
		CASAMBI <span style="color: #0070C0;">new</span>	20 W	2700 K	F	1910 lm	LE015713C	393,86 €
				3000 K	E	2010 lm	LE015714C	
				4000 K	E	2080 lm	LE015770C	
				1800-3000 K dim2warm	F	1540 lm	LE015715C	
	<b>Glas M long mit Reflektor</b> glass M long with reflector						DU015803	256,47 €

	<b>Glas M short mit Reflektor</b> glass M short with reflector						DU015804	196,93 €
---	---	--	--	--	--	--	----------	----------





 IP40    
modular protection emergency battery  
article class light option option

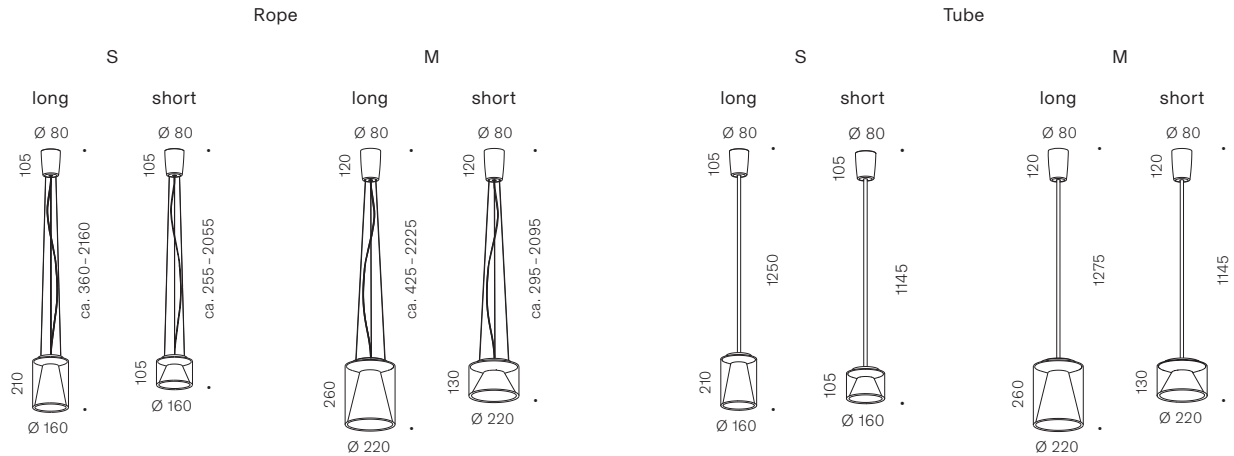



LED     

# DRUM Suspension







## DRUM Suspension S new

Abbildung figure	Beschreibung description	Regelung control	Leistung power	CCT	EK EEC	Lumen lumen	Art.-Nr. art.-no.	€ netto CH excl. VAT		
	<b>LIGHT ENGINE</b> Suspension Rope S	TRIAC	11 W	2700K	E	1170 lm	LE015704	403,03 €		
				3000K	E	1230 lm	LE015705			
				4000K <span style="color: blue;">new</span>	E	1280 lm	LE015738			
				1800-3000K dim2warm	F	870 lm	LE015706		435,08 €	
				2700K	E	1170 lm	LE015735		435,08 €	
				3000K	E	1230 lm	LE015736			
		4000K <span style="color: blue;">new</span>	E	1280 lm	LE015739					
		DALI	11 W	1800-3000K dim2warm	F	870 lm	LE015737	467,14 €		
				CASAMBI <span style="color: blue;">new</span>	11 W	2700K	E	1170 lm	LE015704C	494,62 €
						3000K	E	1230 lm	LE015736C	
		4000K	E			1280 lm	LE015738C			
			<b>LIGHT ENGINE</b> Suspension Tube S	TRIAC	11 W	1800-3000K dim2warm	F	870 lm	LE015737C	517,52 €
2700K	E					1170 lm	LE015707	357,23 €		
3000K	E					1230 lm	LE015708			
4000K <span style="color: blue;">new</span>	E					1280 lm	LE015743			
DALI	11 W					1800-3000K dim2warm	F	870 lm	LE015709	393,86 €
						2700K	E	1170 lm	LE015740	393,86 €
				3000K	E	1230 lm	LE015741			
4000K <span style="color: blue;">new</span>	E			1280 lm	LE015744					
CASAMBI <span style="color: blue;">new</span>	11 W			1800-3000K dim2warm	F	870 lm	LE015742	425,93 €		
				2700K	E	1170 lm	LE015740C	448,82 €		
				3000K	E	1230 lm	LE015741C			
4000K	E			1280 lm	LE015743C					
1800-3000K dim2warm	F	870 lm	LE015742C	485,46 €						
	<b>Glas S long mit Reflektor</b> glass S long with reflector						DU015801	215,25 €		
	<b>Glas S short mit Reflektor</b> glass S short with reflector						DU015802	164,87 €		

 modular article  
 IP20 protection class  
 tube cuttable  
 + length option

 LED  
 dimmable  
 Zhaga standard  
 dim2warm  
 CRI > 97  
 SDCM 3

# DRUM Suspension M new

Abbildung figure	Beschreibung description	Regelung control	Leistung power	CCT	EELCC	Lumen lumen	Art.-Nr. art.-no.	€ netto CH excl. VAT	
	<b>LIGHT ENGINE</b> Suspension Rope M	TRIAC	27 W	2700 K	F	1910 lm	LE015716	485,46 €	
				3000 K	E	2010 lm	LE015717		
				4000 K <span style="color: #0070C0;">new</span>	E	2080 lm	LE015772		
				1800-3000 K dim2warm	F	1540 lm	LE015718		526,68 €
				2700 K	F	1910 lm	LE015719		517,52 €
				3000 K	E	2010 lm	LE015720		
		4000 K <span style="color: #0070C0;">new</span>	E	2080 lm	LE015773				
		1800-3000 K dim2warm	F	1540 lm	LE015721	558,74 €			
		2700 K	F	1910 lm	LE015716C	572,48 €			
		3000 K	E	2010 lm	LE015720C				
		4000 K	E	2080 lm	LE015773C				
		1800-3000 K dim2warm	F	1540 lm	LE015718C		618,28 €		
	<b>LIGHT ENGINE</b> Suspension Tube M	TRIAC	27 W	2700 K	F		1910 lm	LE015722	435,08 €
				3000 K	E		2010 lm	LE015723	
				4000 K <span style="color: #0070C0;">new</span>	E	2080 lm	LE015728		
				1800-3000 K dim2warm	F	1540 lm	LE015724	476,30 €	
				2700 K	F	1910 lm	LE015725	467,14 €	
				3000 K	E	2010 lm	LE015726		
		4000 K <span style="color: #0070C0;">new</span>	E	2080 lm	LE015729				
		1800-3000 K dim2warm	F	1540 lm	LE015727	512,94 €			
		2700 K	F	1910 lm	LE015722C	517,52 €			
		3000 K	E	2010 lm	LE015723C				
		4000 K	E	2080 lm	LE015729C				
		1800-3000 K dim2warm	F	1540 lm	LE015724C		549,58 €		
	<b>Glas M long mit Reflektor</b> glass M long with reflector						DU015803	256,47 €	
	<b>Glas M short mit Reflektor</b> glass M short with reflector						DU015804	196,93 €	

 modular article  
  IP20 protection class  
  tube cuttable  
  + length option  
  emergency light option

LED  
  dimmable  
  Zhaga standard  
  dim2warm  
  CRI >97  
  SDCM 3



**Black Edition – Leuchtenkörper und Innenschirm in mattem Schwarz – für eine besonders eindrucksvolle, magische Lichtwirkung. Bei Fragen zur Sonderedition wenden Sie sich bitte an den Vertrieb.**  
 Black Edition – Lamp body and inner shade in matt black – for a particularly striking, magical lighting effect.  
 If you have any questions about the special edition, please contact our sales department.



**Winkeladapter für Dachschrägen in weiß erhältlich – Montagehilfe für einfache Installation.**  
**Der Winkel kann individuell angefertigt werden – Sonderfarben auf Anfrage.**  
**Bestellungen (Art.-Nr.: ZB1012) bitte in Abstimmung mit dem Vertrieb.**  
 Angle brackets for sloping roofs available in white – to assist with easy installation.  
 The brackets can be made to measure – special colours available on request.  
 Please coordinate orders (art.-no.: ZB1012) with the sales department.

# JOB Table

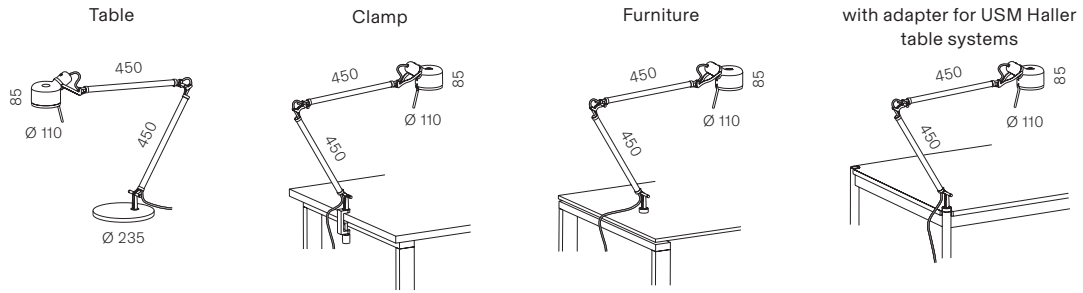

## JOB Table

Abbildung figure	Beschreibung description	Leuchtmittel lamp	Regelung control	Leistung power	CCT	EEK EEC	Lumen lumen	Art.-Nr. art.-no.	€ netto CH excl. VAT
	<b>Table</b>	LED E27	integr.	13 W	2200-2700 K dim2warm	E	1521 lm	JB1013	1.328,15 €
	<b>Clamp</b>	LED E27	integr.	13 W	2200-2700 K dim2warm	E	1521 lm	JB1014	1.117,48 €
	<b>Furniture</b>	LED E27	integr.	13 W	2200-2700 K dim2warm	E	1521 lm	JB1015	1.025,89 €
	<b>mit Adapter für USM Haller Tischsysteme with adapter for USM Haller table systems</b>	LED E27	integr.	13 W	2200-2700 K dim2warm	E	1521 lm	JB1016	1.025,89 €

IP20  
protection  
class

  
lamp  
included

 dimmable

 dim2warm

 CRI >90

# JONES Floor

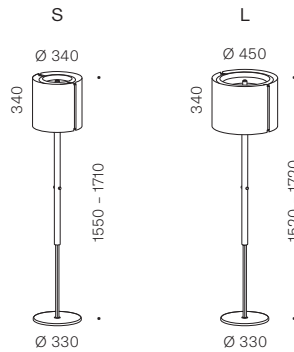

## JONES Floor

Abbildung figure	Beschreibung description	Leuchtmittel lamp	Regelung control	Leistung power	CCT	EEK EEC	Lumen lumen	Art.-Nr. art.-no.	€ netto CH excl. VAT
●	<b>S gebürstet</b> S brushed	LED	integr.	38 W	2700 K	E	3500lm	JO3016	1.822,77 €
		E27	integr.	max. 205 W	3000 K	G	4200lm	JO1010	1.364,79 €
	<b>L gebürstet</b> L brushed	LED	integr.	38 W	2700 K	E	3500lm	JO3015	1.822,77 €
		E27	integr.	max. 205 W	3000 K	G	4200lm	JO1007	1.364,79 €
●	<b>S schwarz</b> S black	LED	integr.	38 W	2700 K	E	3500lm	JO3117	1.822,77 €
		<b>L schwarz</b> L black	LED	integr.	38 W	2700 K	E	3500lm	



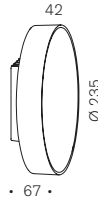

IP20  
protection  
class

 dimmable
  Zhaga  
standard
  CRI >97
  SDCM 2

# LYD Wall







## LYD Wall

Abbildung figure	Beschreibung description	Regelung control	Leistung power	CCT	EEK EEC	Lumen lumen	Art.-Nr. art.-no.	€ netto CH excl. VAT
	<b>Leuchteinheit LYD</b> lighting unit LYD	TRIAC	16 W	2700K	E	1970lm	LD1001	348,07 €
				3000K	E	2010lm	LD1002	
		DALI	22 W	2700K	E	1970lm	LD1005	389,28 €
				3000K	E	2010lm	LD1006	
	<b>Front Aluminium champagner eloxiert</b> front aluminium champagne anodized						LD1103	109,92 €
	<b>Front Aluminium silber eloxiert</b> front aluminium silver anodized						LD1104	
	<b>Front Echtglas opal</b> front genuine glass opal						LD1101	
	<b>Front Spiegel</b> front genuine glass mirror						LD1102	



## LYD Wall IP44

Abbildung figure	Beschreibung description	Regelung control	Leistung power	CCT	EEK EEC	Lumen lumen	Art.-Nr. art.-no.	€ netto CH excl. VAT
	<b>Leuchteinheit LYD IP44</b> lighting unit LYD IP44	TRIAC	16 W	2700K	E	1970lm	LD1201	389,28 €
				3000K	E	2010lm	LD1202	
		DALI	22 W	2700K	E	1970lm	LD1205	416,76 €
				3000K	E	2010lm	LD1206	
	<b>IP44 Front Aluminium champagner eloxiert</b> front aluminium champagne anodized						LD1303	137,39 €
	<b>IP44 Front Aluminium silber eloxiert</b> front aluminium silver anodized						LD1304	
	<b>IP44 Front Echtglas opal</b> front genuine glass opal						LD1301	
	<b>IP44 Front Spiegel</b> front genuine glass mirror						LD1302	



## Zubehör/Accessories

Abbildung figure	Beschreibung description	Art.-Nr. art.-no.	€ netto CH excl. VAT
	<b>Spiegeladapter Set</b> mirror adapter set	ZB1001	41,22 €

# ONE EIGHTY Suspension

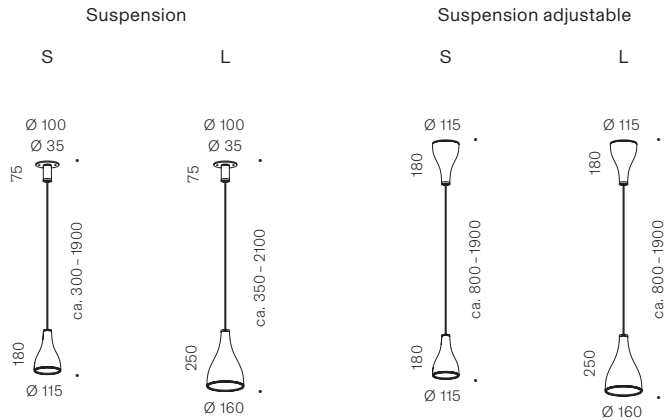

## ONE EIGHTY Suspension

Abbildung figure	Beschreibung description	Fassung socket	Regelung control	Leistung power	E EK EEC	Art.-Nr. art.-no.	€ netto CH excl. VAT
●	<b>S schwarz</b> S black	GU10	TRIAC	max. 60 W	G	OE1021	366,38 €
○	<b>S weiß</b> S white	GU10	TRIAC	max. 60 W	G	OE1003	
●	<b>S höhenverstellbar, schwarz</b> S adjustable, black	GU10	TRIAC	max. 60 W	G	OE1022	457,99 €
○	<b>S höhenverstellbar, weiß</b> S adjustable, white	GU10	TRIAC	max. 60 W	G	OE1004	
●	<b>L schwarz</b> L black	E27	TRIAC	max. 100 W	G	OE1023	412,18 €
○	<b>L weiß</b> L white	E27	TRIAC	max. 100 W	G	OE1007	
●	<b>L höhenverstellbar, schwarz</b> L adjustable, black	E27	TRIAC	max. 100 W	G	OE1024	522,10 €
○	<b>L höhenverstellbar, weiß</b> L adjustable, white	E27	TRIAC	max. 100 W	G	OE1008	

IP20  
protection  
class





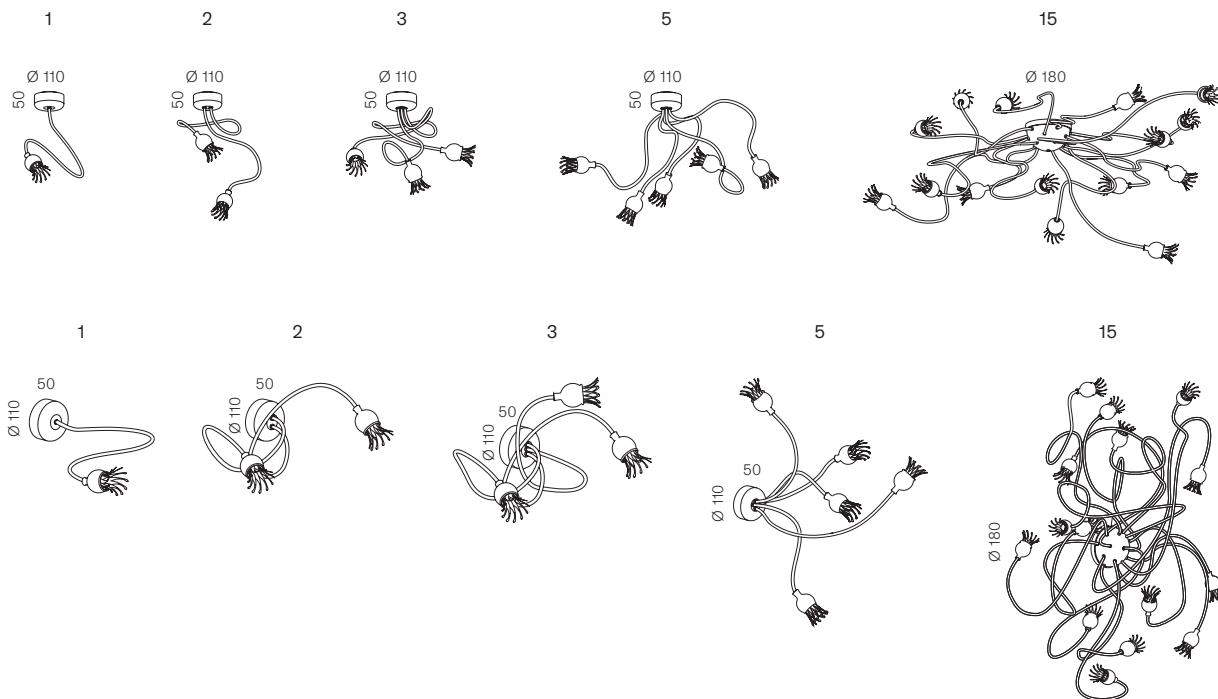



















  
dimmable

# POPPY Ceiling/Wall



## POPPY Ceiling/Wall

Abbildung figure	Beschreibung description	Fassung socket	Regelung control	Leistung power	E EK EEC	Art.-Nr. art.-no.	€ netto CH excl. VAT
	<b>1 Arm schwarz, Schirm keramik</b> 1 arm black, shade ceramic	G4	ON/OFF	max. 35 W	G	PO1025	
	<b>1 Arm schwarz, Schirm rubinrot</b> 1 arm black, shade ruby red	G4	ON/OFF	max. 35 W	G	PO1026	
	<b>1 Arm schwarz, Schirm violett</b> 1 arm black, shade violet	G4	ON/OFF	max. 35 W	G	PO1027	
	<b>1 Arm beige, Schirm keramik</b> 1 arm beige shade ceramic	G4	ON/OFF	max. 35 W	G	PO1028	430,51 €
	<b>1 Arm beige, Schirm rubinrot</b> 1 arm beige shade ruby red	G4	ON/OFF	max. 35 W	G	PO1029	
	<b>1 Arm beige, Schirm violett</b> 1 arm beige shade violet	G4	ON/OFF	max. 35 W	G	PO1030	
	<b>2 Arme schwarz, Schirme keramik</b> 2 arms black, shades ceramic	2 × G4	ON/OFF	max. 70 W	G	PO1031	
	<b>2 Arme schwarz, Schirme rubinrot</b> 2 arms black, shades ruby red	2 × G4	ON/OFF	max. 70 W	G	PO1032	
	<b>2 Arme schwarz, Schirme violett</b> 2 arms black, shades violet	2 × G4	ON/OFF	max. 70 W	G	PO1033	
	<b>2 Arme beige, Schirme keramik</b> 2 arms beige shades ceramic	2 × G4	ON/OFF	max. 70 W	G	PO1034	540,42 €
	<b>2 Arme beige, Schirme rubinrot</b> 2 arms beige shades ruby red	2 × G4	ON/OFF	max. 70 W	G	PO1035	
	<b>2 Arme beige, Schirme violett</b> 2 arms beige shades violet	2 × G4	ON/OFF	max. 70 W	G	PO1036	





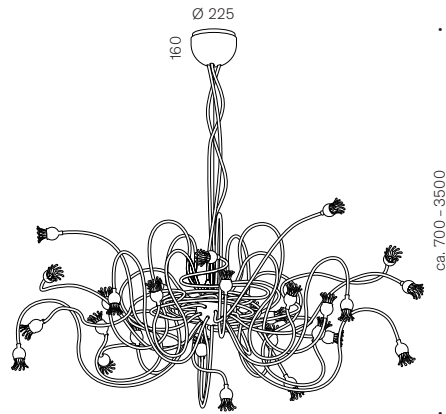

Abbildung figure	Beschreibung description	Fassung socket	Regelung control	Leistung power	EEK EEC	Art.-Nr. art.-no.	€ netto CH excl. VAT
	<b>3 Arme schwarz, Schirme keramik</b> 3 arms black, shades ceramic	3 × G4	ON/OFF	max. 105 W	G	PO1037	650,34 €
	<b>3 Arme schwarz, Schirme rubinrot</b> 3 arms black, shades ruby red	3 × G4	ON/OFF	max. 105 W	G	PO1038	
	<b>3 Arme schwarz, Schirme violett</b> 3 arms black, shades violet	3 × G4	ON/OFF	max. 105 W	G	PO1039	
	<b>3 Arme beige, Schirme keramik</b> 3 arms beige shades ceramic	3 × G4	ON/OFF	max. 105 W	G	PO1040	
	<b>3 Arme beige, Schirme rubinrot</b> 3 arms beige shades ruby red	3 × G4	ON/OFF	max. 105 W	G	PO1041	
	<b>3 Arme beige, Schirme violett</b> 3 arms beige shades violet	3 × G4	ON/OFF	max. 105 W	G	PO1042	
	<b>5 Arme schwarz, Schirme keramik</b> 5 arms black, shades ceramic	5 × G4	ON/OFF	max. 100 W	G	PO1043	842,69 €
	<b>5 Arme schwarz, Schirme rubinrot</b> 5 arms black, shades ruby red	5 × G4	ON/OFF	max. 100 W	G	PO1044	
	<b>5 Arme schwarz, Schirme violett</b> 5 arms black, shades violet	5 × G4	ON/OFF	max. 100 W	G	PO1045	
	<b>5 Arme beige, Schirme keramik</b> 5 arms beige shades ceramic	5 × G4	ON/OFF	max. 100 W	G	PO1046	
	<b>5 Arme beige, Schirme rubinrot</b> 5 arms beige shades ruby red	5 × G4	ON/OFF	max. 100 W	G	PO1047	
	<b>5 Arme beige, Schirme violett</b> 5 arms beige shades violet	5 × G4	ON/OFF	max. 100 W	G	PO1048	
	<b>15 Arme 75 cm schwarz, Schirme keramik</b> 15 arms 75 cm black, shades ceramic	15 × G4	ON/OFF	max. 300 W	G	PO1007	1.923,53 €
	<b>15 Arme 75 cm schwarz, Schirme rubinrot</b> 15 arms 75 cm black, shades ruby red	15 × G4	ON/OFF	max. 300 W	G	PO1008	
	<b>15 Arme 75 cm schwarz, Schirme violett</b> 15 arms 75 cm black, shades violet	15 × G4	ON/OFF	max. 300 W	G	PO1009	
	<b>15 Arme 75 cm beige, Schirme keramik</b> 15 arms 75 cm beige, shades ceramic	15 × G4	ON/OFF	max. 300 W	G	PO1013	
	<b>15 Arme 75 cm beige, Schirme rubinrot</b> 15 arms 75 cm beige, shades ruby red	15 × G4	ON/OFF	max. 300 W	G	PO1014	
	<b>15 Arme 75 cm beige, Schirme violett</b> 15 arms 75 cm beige, shades violet	15 × G4	ON/OFF	max. 300 W	G	PO1015	
	<b>15 Arme 150 cm schwarz, Schirme keramik</b> 15 arms 150 cm black, shades ceramic	15 × G4	ON/OFF	max. 300 W	G	PO1010	2.015,13 €
	<b>15 Arme 150 cm schwarz, Schirme rubinrot</b> arms 150 cm black, shades ruby red	15 × G4	ON/OFF	max. 300 W	G	PO1011	
	<b>15 Arme 150 cm schwarz, Schirme violett</b> 15 arms 150 cm black, shades violet	15 × G4	ON/OFF	max. 300 W	G	PO1012	
	<b>15 Arme 150 cm beige, Schirme keramik</b> 15 arms 150 cm beige, shades ceramic	15 × G4	ON/OFF	max. 300 W	G	PO1016	
	<b>15 Arme 150 cm beige, Schirme rubinrot</b> 15 arms 150 cm beige, shades ruby red	15 × G4	ON/OFF	max. 300 W	G	PO1017	
	<b>15 Arme 150 cm beige, Schirme violett</b> 15 arms 150 cm beige, shades violet	15 × G4	ON/OFF	max. 300 W	G	PO1018	

IP20   
protection class lamp included

# POPPY Suspension



## POPPY Suspension

Abbildung figure	Beschreibung description	Fassung socket	Regelung control	Leistung power	E EK EEC	Art.-Nr. art.-no.	€ netto CH excl. VAT
	<b>30 Arme schwarz, Schirme keramik</b> 30 arms black, shades ceramic	30 × G4	ON/OFF	max. 600 W	G	PO1004	4.763,03 €
	<b>30 Arme schwarz, Schirme rubinrot</b> 30 arms black, shades red	30 × G4	ON/OFF	max. 600 W	G	PO1005	
	<b>30 Arme schwarz, Schirme violett</b> 30 arms black, shades violet	30 × G4	ON/OFF	max. 600 W	G	PO1006	
	<b>30 Arme beige, Schirme keramik</b> 30 arms beige shades ceramic	30 × G4	ON/OFF	max. 600 W	G	PO1019	
	<b>30 Arme beige, Schirme rubinrot</b> 30 arms beige shades red	30 × G4	ON/OFF	max. 600 W	G	PO1020	
	<b>30 Arme beige, Schirme violett</b> 30 arms beige shades violet	30 × G4	ON/OFF	max. 600 W	G	PO1021	

IP20   
protection class lamp included

# POPPY Table

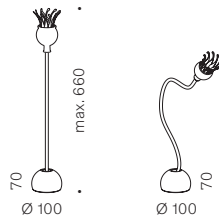

## POPPY Table

Abbildung figure	Beschreibung description	Fassung socket	Regelung control	Leistung power	EEK EEC	Art.-Nr. art.-no.	€ netto CH excl. VAT
	<b>Arme schwarz, Schirm keramik</b> arms black, shade ceramic	G4	ON/OFF	max. 35 W	G	PO1001	384,70 €
	<b>Arme schwarz, Schirm rubinrot</b> arms black, shade ruby red	G4	ON/OFF	max. 35 W	G	PO1002	
	<b>Arme schwarz, Schirm violett</b> arms black, shade violet	G4	ON/OFF	max. 35 W	G	PO1003	
	<b>Arme beige, Schirm keramik</b> arms beige shade ceramic	G4	ON/OFF	max. 35 W	G	PO1022	
	<b>Arme beige, Schirm rubinrot</b> arms beige shade ruby red	G4	ON/OFF	max. 35 W	G	PO1023	
	<b>Arme beige, Schirm violett</b> arms beige shade violet	G4	ON/OFF	max. 35 W	G	PO1024	

IP20 lamp included  
protection class

# POPPY Floor

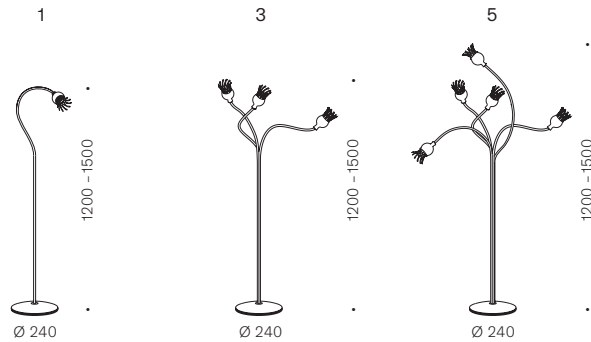

## POPPY Floor

Abbildung figure	Beschreibung description	Fassung lamp	Regelung control	Leistung power	E EK EEC	Art.-Nr. art.-no.	€ netto CH excl. VAT
	<b>1 Arm schwarz, Schirm keramik</b> 1 arm black, shade ceramic	G4 35 W	ON/OFF	35 W	G	PO1052	540,42 €
	<b>1 Arm schwarz, Schirm rubinrot</b> 1 arm black, shade red	G4 35 W	ON/OFF	35 W	G	PO1051	
	<b>1 Arm schwarz, Schirm violett</b> 1 arm black, shade violet	G4 35 W	ON/OFF	35 W	G	PO1050	
	<b>1 Arm beige, Schirm keramik</b> 1 arm beige shade ceramic	G4 35 W	ON/OFF	35 W	G	PO1055	
	<b>1 Arm beige, Schirm rubinrot</b> 1 arm beige shade red	G4 35 W	ON/OFF	35 W	G	PO1054	
	<b>1 Arm beige, Schirm violett</b> 1 arm beige shade violet	G4 35 W	ON/OFF	35 W	G	PO1053	
	<b>3 Arme schwarz, Schirme keramik</b> 3 arms black, shades ceramic	3 × G4 35 W	ON/OFF	105 W	G	PO1058	751,10 €
	<b>3 Arme schwarz, Schirme rubinrot</b> 3 arms black, shades red	3 × G4 35 W	ON/OFF	105 W	G	PO1057	
	<b>3 Arme schwarz, Schirme violett</b> 3 arms black, shades violet	3 × G4 35 W	ON/OFF	105 W	G	PO1056	
	<b>3 Arme beige, Schirme keramik</b> 3 arms beige shades ceramic	3 × G4 35 W	ON/OFF	105 W	G	PO1061	
	<b>3 Arme beige, Schirme rubinrot</b> 3 arms beige shades red	3 × G4 35 W	ON/OFF	105 W	G	PO1060	
	<b>3 Arme beige, Schirme violett</b> 3 arms beige shades violet	3 × G4 35 W	ON/OFF	105 W	G	PO1059	
	<b>5 Arme schwarz, Schirme keramik</b> 5 arms black, shades ceramic	5 × G4 20 W	ON/OFF	100 W	G	PO1064	952,61 €
	<b>5 Arme schwarz, Schirme rubinrot</b> 5 arms black, shades red	5 × G4 20 W	ON/OFF	100 W	G	PO1063	
	<b>5 Arme schwarz, Schirme violett</b> 5 arms black, shades violet	5 × G4 20 W	ON/OFF	100 W	G	PO1062	
	<b>5 Arme beige, Schirme keramik</b> 5 arms beige shades ceramic	5 × G4 20 W	ON/OFF	100 W	G	PO1067	
	<b>5 Arme beige, Schirme rubinrot</b> 5 arms beige shades red	5 × G4 20 W	ON/OFF	100 W	G	PO1066	
	<b>5 Arme beige, Schirme violett</b> 5 arms beige shades violet	5 × G4 20 W	ON/OFF	100 W	G	PO1065	

IP20 lamp  
protection class included

# REEF Ceiling

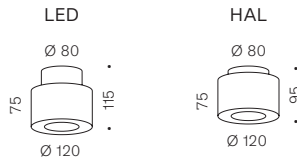

## REEF Ceiling

Abbildung figure	Beschreibung description	Leuchtmittel lamp	Regelung control	Leistung power	CCT	EEK EEC	Lumen lumen	Art.-Nr. art.-no.	€ netto CH excl. VAT
●	<b>gebürstet</b> brushed	LED	TRIAC	8 W	2700 K	F	680 lm	RF2007	366,38 €
		G9	TRIAC	max. 33 W	2700 K	G	460 lm	RF1012	228,99 €
●	<b>poliert</b> polished	LED	TRIAC	8 W	2700 K	E	680 lm	RF2009	375,55 €
		G9	TRIAC	max. 33 W	2700 K	F	460 lm	RF1017	238,15 €

IP20  
protection class



# REEF Suspension

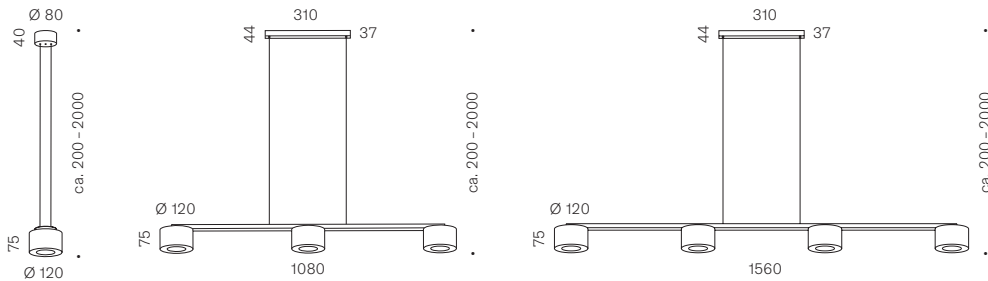

## REEF Suspension

Abbildung figure	Beschreibung description	Regelung control	Leistung power	CCT	EEK EEC	Lumen lumen	Art.-Nr. art.-no.	€ netto CH excl. VAT
●	<b>1 gebürstet</b> 1 brushed	TRIAC	8 W	2700 K	F	680 lm	RF2018	407,61 €
●	<b>1 poliert</b> 1 polished	TRIAC	8 W	2700 K	F	680 lm	RF2017	
●	<b>3 gebürstet</b> 3 brushed	LED	26 W	2700 K	F	2400 lm	RF2021	1.236,55 €
		3 × G9	TRIAC	max. 180 W	2700 K	F	2940 lm	RF1006
●	<b>4 gebürstet</b> 4 brushed	LED	38 W	2700 K	F	3190 lm	RF2031	1.419,75 €
		4 × G9	TRIAC	max. 240 W	2700 K	F	3020 lm	RF1008

IP20  
protection class

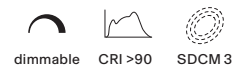

# REEF Wall

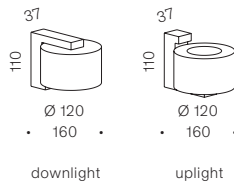

## REEF Wall

Abbildung figure	Beschreibung description	Leuchtmittel lamp	Regelung control	Leistung power	CCT	EEL EEC	Lumen lumen	Art.-Nr. art.-no.	€ netto CH excl. VAT
●	<b>gebürstet</b> brushed	LED	TRIAC	8 W	2700 K	F	680 lm	RF2057	421,34 €
		G9	TRIAC	max. 60 W	2700 K	G	740 lm	RF1002	316,01 €
●	<b>poliert</b> polished	LED	TRIAC	8 W	2700 K	F	680 lm	RF2058	448,82 €
		G9	TRIAC	max. 60 W	2700 K	G	740 lm	RF1001	338,90 €

IP20  
protection  
class

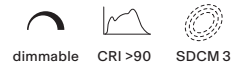

## Zubehör/Accessories

Abbildung figure	Beschreibung description	Art.-Nr. art.-no.	€ netto CH excl. VAT
	<b>Spiegeladapter Set ROD</b> mirror adapter set ROD	ZB1004	41,22 €

# REFLEX<sup>2</sup> Ceiling

S

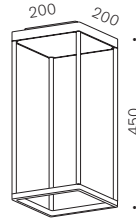
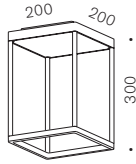
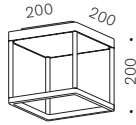
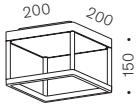

M

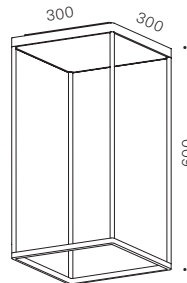
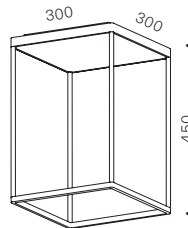
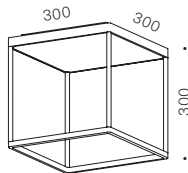
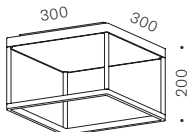
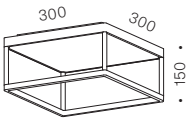

XL

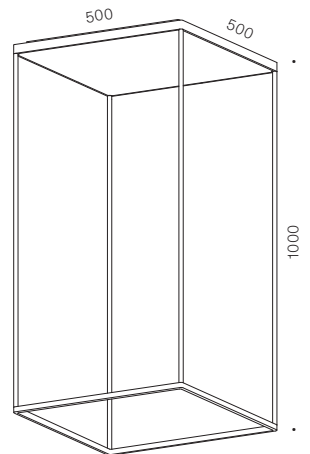
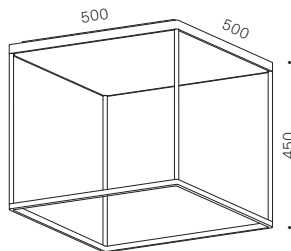
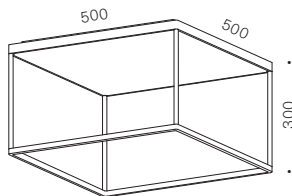
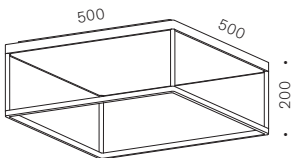

REFLEX<sup>2</sup> Ceiling ist auch für die Wandmontage geeignet.  
REFLEX<sup>2</sup> Ceiling is also suitable for wall mounting.

# REFLEX<sup>2</sup> Ceiling Cascade

Cascade M / S

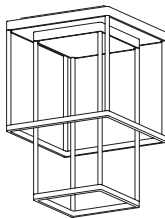

M



**REFLEX<sup>2</sup> Ceiling M**  
+ Reflektor Cascade M

S



**REFLEX<sup>2</sup> Ceiling S**  
+ Reflektor S

€ netto CH

ab 1.214,30 €

Cascade XL / M

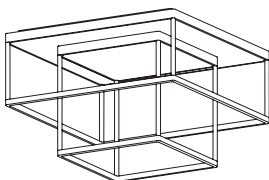

XL



**REFLEX<sup>2</sup> Ceiling XL**  
+ Reflektor Cascade XL

M



**REFLEX<sup>2</sup> Ceiling M**  
+ Reflektor M

€ netto CH

ab 1.662,50 €

Cascade XL / M / S

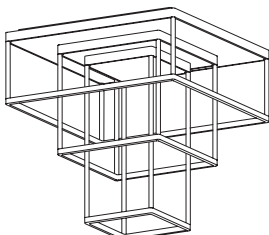

XL



**REFLEX<sup>2</sup> Ceiling XL**  
+ Reflektor Cascade XL

M



**REFLEX<sup>2</sup> Ceiling M**  
+ Reflektor Cascade M

S



**REFLEX<sup>2</sup> Ceiling S**  
+ Reflektor S

€ netto CH

ab 2.198,98 €

# REFLEX<sup>2</sup> Ceiling S new





Abbildung figure	Beschreibung description	Regelung control	Leistung power	CCT	EEL EEC	Lumen lumen	Art.-Nr. art.-no.	€ netto CH excl. VAT
●	150 schwarz 150 black	TRIAC	33 W	2700 K	E	3640 lm	RE2450	375,51 €
				3000 K	E	3800 lm	RE2451	
				2200-3000 K dim2warm	E	3640 lm	RE2401	
		DALI	33 W	2700 K	E	3640 lm	RE2460	421,29 €
				3000 K	E	3800 lm	RE2461	
				2200-3000 K dim2warm	E	3640 lm	RE2402	
		CASAMBI	33 W	2200-5000 K tunable white <span style="color: #0070C0;">new</span>	E	3960 lm	RE2470	512,85 €
				2700 K <span style="color: #0070C0;">new</span>	E	3640 lm	RE2460C	462,49 €
				3000 K <span style="color: #0070C0;">new</span>	E	3800 lm	RE2461C	
		2200-3000 K dim2warm	E	3640 lm	RE2402C	503,69 €		
		CASAMBI	33 W	2200-5000 K tunable white <span style="color: #0070C0;">new</span>	E	3960 lm	RE2470C	554,16 €
				TRIAC	33 W	2700 K	E	3640 lm
3000 K	E					3800 lm	RE2453	
2200-3000 K dim2warm	E	3640 lm	RE2403			416,71 €		
DALI	33 W	2700 K	E	3640 lm	RE2462	421,29 €		
		3000 K	E	3800 lm	RE2463			
		2200-3000 K dim2warm	E	3640 lm	RE2404		462,49 €	
CASAMBI	33 W	2200-5000 K tunable white <span style="color: #0070C0;">new</span>	E	3960 lm	RE2471	512,85 €		
		2700 K <span style="color: #0070C0;">new</span>	E	3640 lm	RE2462C	462,49 €		
		3000 K <span style="color: #0070C0;">new</span>	E	3800 lm	RE2463C			
2200-3000 K dim2warm	E	3640 lm	RE2404C	503,69 €				
CASAMBI	33 W	2200-5000 K tunable white <span style="color: #0070C0;">new</span>	E	3960 lm	RE2471C	554,16 €		
		TRIAC	33 W	2700 K	E	3640 lm	RE2550	375,51 €
				3000 K	E	3800 lm	RE2551	
2200-3000 K dim2warm	E			3640 lm	RE2501	416,71 €		
DALI	33 W	2700 K	E	3640 lm	RE2560	421,29 €		
		3000 K	E	3800 lm	RE2561			
		2200-3000 K dim2warm	E	3640 lm	RE2502		462,49 €	
CASAMBI	33 W	2200-5000 K tunable white <span style="color: #0070C0;">new</span>	E	3960 lm	RE2570	512,85 €		
		2700 K <span style="color: #0070C0;">new</span>	E	3640 lm	RE2560C	462,49 €		
		3000 K <span style="color: #0070C0;">new</span>	E	3800 lm	RE2561C			
2200-3000 K dim2warm	E	3640 lm	RE2502C	503,69 €				
CASAMBI	33 W	2200-5000 K tunable white <span style="color: #0070C0;">new</span>	E	3960 lm	RE2570C	554,16 €		
		TRIAC	33 W	2700 K	E	3640 lm	RE2552	375,51 €
				3000 K	E	3800 lm	RE2553	
2200-3000 K dim2warm	E			3640 lm	RE2503	416,71 €		
DALI	33 W	2700 K	E	3640 lm	RE2562	421,29 €		
		3000 K	E	3800 lm	RE2563			
		2200-3000 K dim2warm	E	3640 lm	RE2504		462,49 €	
CASAMBI	33 W	2200-5000 K tunable white <span style="color: #0070C0;">new</span>	E	3960 lm	RE2571	512,85 €		
		2700 K <span style="color: #0070C0;">new</span>	E	3640 lm	RE2562C	462,49 €		
		3000 K <span style="color: #0070C0;">new</span>	E	3800 lm	RE2563C			
2200-3000 K dim2warm	E	3640 lm	RE2504C	503,69 €				
CASAMBI	33 W	2200-5000 K tunable white <span style="color: #0070C0;">new</span>	E	3960 lm	RE2571C	554,16 €		

# REFLEX<sup>2</sup> Ceiling S new

Abbildung figure	Beschreibung description	Regelung control	Leistung power	CCT	E EK EEC	Lumen lumen	Art.-Nr. art.-no.	€ netto CH excl. VAT
●	300 schwarz 300 black	TRIAC	33 W	2700 K	E	3640 lm	RE2650	375,51 €
				3000 K	E	3800 lm	RE2651	
				2200-3000 K dim2warm	E	3640 lm	RE2601	
		DALI	33 W	2700 K	E	3640 lm	RE2660	421,29 €
				3000 K	E	3800 lm	RE2661	
				2200-3000 K dim2warm	E	3640 lm	RE2602	
		CASAMBI	33 W	2200-5000 K tunable white <span style="color: #0070C0;">new</span>	E	3960 lm	RE2670	512,85 €
				2700 K <span style="color: #0070C0;">new</span>	E	3640 lm	RE2660C	462,49 €
				3000 K <span style="color: #0070C0;">new</span>	E	3800 lm	RE2661C	
		CASAMBI	33 W	2200-3000 K dim2warm	E	3640 lm	RE2602C	503,69 €
				2200-5000 K tunable white <span style="color: #0070C0;">new</span>	E	3960 lm	RE2670C	554,16 €
				2700 K	E	3640 lm	RE2652	375,51 €
TRIAC	33 W	3000 K	E	3800 lm	RE2653			
		2200-3000 K dim2warm	E	3640 lm	RE2603	416,71 €		
		2700 K	E	3640 lm	RE2662	421,29 €		
DALI	33 W	3000 K	E	3800 lm	RE2663			
		2200-3000 K dim2warm	E	3640 lm	RE2604		462,49 €	
		2200-5000 K tunable white <span style="color: #0070C0;">new</span>	E	3960 lm	RE2671	512,85 €		
CASAMBI	33 W	2700 K <span style="color: #0070C0;">new</span>	E	3640 lm	RE2662C	462,49 €		
		3000 K <span style="color: #0070C0;">new</span>	E	3800 lm	RE2663C			
		2200-3000 K dim2warm	E	3640 lm	RE2604C	503,69 €		
2200-5000 K tunable white <span style="color: #0070C0;">new</span>	E	3960 lm	RE2671C	554,16 €				
●	450 schwarz 450 black	TRIAC	33 W	2700 K	E	3640 lm	RE2750	375,51 €
				3000 K	E	3800 lm	RE2751	
				2200-3000 K dim2warm	E	3640 lm	RE2701	
		DALI	33 W	2700 K	E	3640 lm	RE2760	421,29 €
				3000 K	E	3800 lm	RE2761	
				2200-3000 K dim2warm	E	3640 lm	RE2702	
		CASAMBI	33 W	2200-5000 K tunable white <span style="color: #0070C0;">new</span>	E	3960 lm	RE2770	512,85 €
				2700 K <span style="color: #0070C0;">new</span>	E	3640 lm	RE2760C	462,49 €
				3000 K <span style="color: #0070C0;">new</span>	E	3800 lm	RE2761C	
		CASAMBI	33 W	2200-3000 K dim2warm	E	3640 lm	RE2702C	503,69 €
				2200-5000 K tunable white <span style="color: #0070C0;">new</span>	E	3960 lm	RE2770C	554,16 €
				2700 K	E	3640 lm	RE2752	375,51 €
TRIAC	33 W	3000 K	E	3800 lm	RE2753			
		2200-3000 K dim2warm	E	3640 lm	RE2703	416,71 €		
		2700 K	E	3640 lm	RE2762	421,29 €		
DALI	33 W	3000 K	E	3800 lm	RE2763			
		2200-3000 K dim2warm	E	3640 lm	RE2704		462,49 €	
		2200-5000 K tunable white <span style="color: #0070C0;">new</span>	E	3960 lm	RE2771	512,85 €		
CASAMBI	33 W	2700 K <span style="color: #0070C0;">new</span>	E	3640 lm	RE2762C	462,49 €		
		3000 K <span style="color: #0070C0;">new</span>	E	3800 lm	RE2763C			
		2200-3000 K dim2warm	E	3640 lm	RE2704C	503,69 €		
2200-5000 K tunable white <span style="color: #0070C0;">new</span>	E	3960 lm	RE2771C	554,16 €				

Abbildung figure	Beschreibung description	Regelung control	Leistung power	CCT	E EK EEC	Lumen lumen	Art.-Nr. art.-no.	€ netto CH excl. VAT
●	600 schwarz 600 black	TRIAC	33 W	2700 K	E	3640 lm	RE2950	375,51 €
				3000 K	E	3800 lm	RE2951	
				2200-3000 K dim2warm	E	3640 lm	RE2901	
		DALI	33 W	2700 K	E	3640 lm	RE2960	421,29 €
				3000 K	E	3800 lm	RE2961	
				2200-3000 K dim2warm	E	3640 lm	RE2902	
		CASAMBI	33 W	2200-5000 K tunable white <b>new</b>	E	3960 lm	RE2870	512,85 €
				2700 K <b>new</b>	E	3640 lm	RE2960C	462,49 €
				3000 K <b>new</b>	E	3800 lm	RE2961C	
		CASAMBI	33 W	2200-3000 K dim2warm	E	3640 lm	RE2902C	503,69 €
				2200-5000 K tunable white <b>new</b>	E	3960 lm	RE2870C	554,16 €
				2700 K	E	3640 lm	RE2952	375,51 €
3000 K	E	3800 lm	RE2953					
2200-3000 K dim2warm	E	3640 lm	RE2903	416,71 €				
○	600 weiß 600 white	DALI	33 W	2700 K	E	3640 lm	RE2962	421,29 €
				3000 K	E	3800 lm	RE2963	
				2200-3000 K dim2warm	E	3640 lm	RE2904	
		CASAMBI	33 W	2200-5000 K tunable white <b>new</b>	E	3960 lm	RE2871	513,28 €
				2700 K <b>new</b>	E	3640 lm	RE2962C	462,49 €
				3000 K <b>new</b>	E	3800 lm	RE2963C	
		CASAMBI	33 W	2200-3000 K dim2warm	E	3640 lm	RE2904C	503,69 €
				2200-5000 K tunable white <b>new</b>	E	3960 lm	RE2871C	554,16 €

 modular article  
 IP20 protection class  
 emergency light option

LED  dimmable  dim2warm  tunable white  CRI >90  SDCM 3

## REFLEX<sup>2</sup> Ceiling S Reflektor

Abbildung figure	Beschreibung description	Art.-Nr. art.-no.	€ netto CH excl. VAT
○	Pyramidenstruktur weiß pyramid structure white	RE3051	91,59 €
●	Pyramidenstruktur silber pyramid structure silver	RE3052	
●	Pyramidenstruktur gold pyramid structure gold	RE3053	
○	matt weiß matte white	RE3054	

 modular article

# REFLEX<sup>2</sup> Ceiling M new



Abbildung figure	Beschreibung description	Regelung control	Leistung power	CCT	EЕК EEC	Lumen lumen	Art.-Nr. art.-no.	€ netto CH excl. VAT		
●	150 schwarz 150 black	TRIAC	40W	2700K	E	4840lm	RE2001	572,48 €		
				3000K	E	4920lm	RE2002			
		DALI	50W	2700K	E	6350lm	RE2003	622,86 €		
				3000K	E	6450lm	RE2004			
				2200-5000K tunable white	E	6580lm	RE2005			
		CASAMBI	50W	2700K <span style="background-color: #0070C0; color: white; padding: 2px;">new</span>	E	6350lm	RE2003C	709,87 €		
				3000K <span style="background-color: #0070C0; color: white; padding: 2px;">new</span>	E	6450lm	RE2004C			
				2200-5000K tunable white	E	6580lm	RE2005C			
		○	150 weiß 150 white	TRIAC	40W	2700K	E	4840lm	RE2006	572,48 €
						3000K	E	4920lm	RE2007	
DALI	50W			2700K	E	6350lm	RE2008	622,86 €		
				3000K	E	6450lm	RE2009			
				2200-5000K tunable white	E	6580lm	RE2010			
CASAMBI	50W			2700K <span style="background-color: #0070C0; color: white; padding: 2px;">new</span>	E	6350lm	RE2008C	709,87 €		
				3000K <span style="background-color: #0070C0; color: white; padding: 2px;">new</span>	E	6450lm	RE2009C			
				2200-5000K tunable white	E	6580lm	RE2010C			
●	200 schwarz 200 black			TRIAC	40W	2700K	E	4840lm	RE2801	572,48 €
						3000K	E	4920lm	RE2802	
		DALI	50W	2700K	E	6350lm	RE2803	622,86 €		
				3000K	E	6450lm	RE2804			
				2200-5000K tunable white	E	6580lm	RE2805			
		CASAMBI	50W	2700K <span style="background-color: #0070C0; color: white; padding: 2px;">new</span>	E	6350lm	RE2803C	709,87 €		
				3000K <span style="background-color: #0070C0; color: white; padding: 2px;">new</span>	E	6450lm	RE2804C			
				2200-5000K tunable white	E	6580lm	RE2805C			
		○	200 weiß 200 white	TRIAC	40W	2700K	E	4840lm	RE2806	572,48 €
						3000K	E	4920lm	RE2807	
DALI	50W			2700K	E	6350lm	RE2808	622,86 €		
				3000K	E	6450lm	RE2809			
				2200-5000K tunable white	E	6580lm	RE2810			
CASAMBI	50W			2700K <span style="background-color: #0070C0; color: white; padding: 2px;">new</span>	E	6350lm	RE2808C	709,87 €		
				3000K <span style="background-color: #0070C0; color: white; padding: 2px;">new</span>	E	6450lm	RE2809C			
				2200-5000K tunable white	E	6580lm	RE2810C			
●	300 schwarz 300 black			TRIAC	40W	2700K	E	4840lm	RE2101	572,48 €
						3000K	E	4920lm	RE2102	
		DALI	50W	2700K	E	6350lm	RE2103	622,86 €		
				3000K	E	6450lm	RE2104			
				2200-5000K tunable white	E	6580lm	RE2105			
		CASAMBI	50W	2700K <span style="background-color: #0070C0; color: white; padding: 2px;">new</span>	E	6350lm	RE2103C	709,87 €		
				3000K <span style="background-color: #0070C0; color: white; padding: 2px;">new</span>	E	6450lm	RE2104C			
				2200-5000K tunable white	E	6580lm	RE2105C			
		○	300 weiß 300 white	TRIAC	40W	2700K	E	4840lm	RE2106	572,48 €
						3000K	E	4920lm	RE2107	
DALI	50W			2700K	E	6350lm	RE2108	622,86 €		
				3000K	E	6450lm	RE2109			
				2200-5000K tunable white	E	6580lm	RE2110			
CASAMBI	50W			2700K <span style="background-color: #0070C0; color: white; padding: 2px;">new</span>	E	6350lm	RE2108C	709,87 €		
				3000K <span style="background-color: #0070C0; color: white; padding: 2px;">new</span>	E	6450lm	RE2109C			
				2200-5000K tunable white	E	6580lm	RE2110C			

Abbildung figure	Beschreibung description	Regelung control	Leistung power	CCT	EEL EEC	Lumen lumen	Art.-Nr. art.-no.	€ netto CH excl. VAT
●	<b>450 schwarz</b> 450 black	TRIAC	40 W	2700 K	E	4840 lm	RE2201	572,48 €
				3000 K	E	4920 lm	RE2202	
				2700 K	E	6350 lm	RE2203	
		DALI	50 W	3000 K	E	6450 lm	RE2204	622,86 €
				2200–5000 K tunable white	E	6580 lm	RE2205	719,03 €
				2700 K <small>new</small>	E	6350 lm	RE2203C	709,87 €
		CASAMBI	50 W	3000 K <small>new</small>	E	6450 lm	RE2204C	709,87 €
				2200–5000 K tunable white	E	6580 lm	RE2205C	806,06 €
				2700 K <small>new</small>	E	6350 lm	RE2203C	709,87 €
○	<b>450 weiß</b> 450 white	TRIAC	40 W	2700 K	E	4840 lm	RE2206	572,48 €
				3000 K	E	4920 lm	RE2207	
				2700 K	E	6350 lm	RE2208	
		DALI	50 W	3000 K	E	6450 lm	RE2209	622,86 €
				2200–5000 K tunable white	E	6580 lm	RE2210	719,03 €
				2700 K <small>new</small>	E	6350 lm	RE2208C	709,87 €
		CASAMBI	50 W	3000 K <small>new</small>	E	6450 lm	RE2209C	709,87 €
				2200–5000 K tunable white	E	6580 lm	RE2210C	806,06 €
				2700 K <small>new</small>	E	6350 lm	RE2208C	709,87 €
●	<b>600 schwarz</b> 600 black	TRIAC	40 W	2700 K	E	4840 lm	RE2301	572,48 €
				3000 K	E	4920 lm	RE2302	
				2700 K	E	6350 lm	RE2303	
		DALI	50 W	3000 K	E	6450 lm	RE2304	622,86 €
				2200–5000 K tunable white	E	6580 lm	RE2305	719,03 €
				2700 K <small>new</small>	E	6350 lm	RE2303C	709,87 €
		CASAMBI	50 W	3000 K <small>new</small>	E	6450 lm	RE2304C	709,87 €
				2200–5000 K tunable white	E	6580 lm	RE2305C	806,06 €
				2700 K <small>new</small>	E	6350 lm	RE2303C	709,87 €
○	<b>600 weiß</b> 600 white	TRIAC	40 W	2700 K	E	4840 lm	RE2306	572,48 €
				3000 K	E	4920 lm	RE2307	
				2700 K	E	6350 lm	RE2308	
		DALI	50 W	3000 K	E	6450 lm	RE2309	622,86 €
				2200–5000 K tunable white	E	6580 lm	RE2310	719,03 €
				2700 K <small>new</small>	E	6350 lm	RE2308C	709,87 €
		CASAMBI	50 W	3000 K <small>new</small>	E	6450 lm	RE2309C	709,87 €
				2200–5000 K tunable white	E	6580 lm	RE2310C	806,06 €
				2700 K <small>new</small>	E	6350 lm	RE2308C	709,87 €

 modular article  
 IP20 protection class  
 emergency light option  
 battery option  
 sensor option

 LED  
 dimmable  
 tunable white  
 CRI >90  
 SDCM 3





## REFLEX<sup>2</sup> Ceiling M Reflektor

Abbildung figure	Beschreibung description	Art.-Nr. art.-no.	€ netto CH excl. VAT
	<b>Pyramidenstruktur weiß</b> pyramid structure white	RE3001	
	<b>Pyramidenstruktur silber</b> pyramid structure silver	RE3002	
	<b>Pyramidenstruktur gold</b> pyramid structure gold	RE3003	105,34 €
	<b>matt weiß</b> matte white	RE3004	

+

modular  
article

## REFLEX<sup>2</sup> Ceiling M Reflektor Cascade

Abbildung figure	Beschreibung description	Art.-Nr. art.-no.	€ netto CH excl. VAT
	<b>Pyramidenstruktur weiß</b> pyramid structure white	RE3221	
	<b>Pyramidenstruktur silber</b> pyramid structure silver	RE3222	
	<b>Pyramidenstruktur gold</b> pyramid structure gold	RE3223	174,72 €
	<b>matt weiß</b> matte white	RE3224	

+

modular  
article

# REFLEX<sup>2</sup> Ceiling XL new



Abbildung figure	Beschreibung description	Regelung control	Leistung power	CCT	EK EEC	Lumen lumen	Art.-Nr. art.-no.	€ netto CH excl. VAT
●	<b>200 schwarz</b> 200 black	ON/OFF	82 W	2700 K	E	9790 lm	RE5500	778,58 €
				3000 K	E	10140 lm	RE5501	
		ON/OFF SENSOR	82 W	2700 K	E	9790 lm	RE5500S	870,17 €
				3000 K	E	10140 lm	RE5501S	
		DALI	85 W	2700 K	E	10310 lm	RE5507	833,53 €
				3000 K	E	10690 lm	RE5508	
		DALI SENSOR	82 W	2700 K	E	9790 lm	RE5507S	925,13 €
				3000 K	E	10140 lm	RE5508S	
		CASAMBI	85 W	2700 K	E	10310 lm	RE5507C	870,17 €
				3000 K	E	10690 lm	RE5508C	
				2200-5000 K tunable white	E	11220 lm	RE5511	943,45 €
				2200-5000 K tunable white	E	11220 lm	RE5511C	980,08 €
○	<b>200 weiß</b> 200 white	ON/OFF	82 W	2700 K	E	9790 lm	RE5520	778,58 €
				3000 K	E	10140 lm	RE5521	
		ON/OFF SENSOR	82 W	2700 K	E	9790 lm	RE5520S	870,17 €
				3000 K	E	10140 lm	RE5521S	
		DALI	85 W	2700 K	E	10310 lm	RE5527	833,53 €
				3000 K	E	10690 lm	RE5528	
		DALI SENSOR	82 W	2700 K	E	9790 lm	RE5527S	925,13 €
				3000 K	E	10140 lm	RE5528S	
		CASAMBI	85 W	2700 K	E	10310 lm	RE5527C	870,17 €
				3000 K	E	10690 lm	RE5528C	
				2200-5000 K tunable white	E	11220 lm	RE5531	943,45 €
				2200-5000 K tunable white	E	11220 lm	RE5531C	980,08 €
●	<b>300 schwarz</b> 300 black	ON/OFF	82 W	2700 K	E	9790 lm	RE5600	778,58 €
				3000 K	E	10140 lm	RE5601	
		ON/OFF SENSOR	82 W	2700 K	E	9790 lm	RE5600S	870,17 €
				3000 K	E	10140 lm	RE5601S	
		DALI	85 W	2700 K	E	10310 lm	RE5607	833,53 €
				3000 K	E	10690 lm	RE5608	
		DALI SENSOR	82 W	2700 K	E	9790 lm	RE5607S	925,13 €
				3000 K	E	10140 lm	RE5608S	
		CASAMBI	85 W	2700 K	E	10310 lm	RE5607C	870,17 €
				3000 K	E	10690 lm	RE5608C	
				2200-5000 K tunable white	E	11220 lm	RE5611	943,45 €
				2200-5000 K tunable white	E	11220 lm	RE5611C	980,08 €
○	<b>300 weiß</b> 300 white	ON/OFF	82 W	2700 K	E	9790 lm	RE5620	778,58 €
				3000 K	E	10140 lm	RE5621	
		ON/OFF SENSOR	82 W	2700 K	E	9790 lm	RE5620S	870,17 €
				3000 K	E	10140 lm	RE5621S	
		DALI	85 W	2700 K	E	10310 lm	RE5627	833,53 €
				3000 K	E	10690 lm	RE5628	
		DALI SENSOR	82 W	2700 K	E	9790 lm	RE5627S	925,13 €
				3000 K	E	10140 lm	RE5628S	
		CASAMBI	85 W	2700 K	E	10310 lm	RE5627C	870,17 €
				3000 K	E	10690 lm	RE5628C	
				2200-5000 K tunable white	E	11220 lm	RE5631	943,45 €
				2200-5000 K tunable white	E	11220 lm	RE5631C	980,08 €

Abbildung figure	Beschreibung description	Regelung control	Leistung power	CCT	EEL EEC	Lumen lumen	Art.-Nr. art.-no.	€ netto CH excl. VAT
●	<b>450 schwarz</b> 450 black	ON/OFF	82 W	2700 K	E	9790lm	RE5800	778,58 €
				3000 K	E	10140lm	RE5801	
		ON/OFF SENSOR	82 W	2700 K	E	9790lm	RE5800S	870,17 €
				3000 K	E	10140lm	RE5801S	
		DALI	85 W	2700 K	E	10310lm	RE5807	833,53 €
				3000 K	E	10690lm	RE5808	
				2200-5000 K tunable white	E	11220lm	RE5811	
		DALI SENSOR	82 W	2700 K	E	9790lm	RE5807S	925,13 €
				3000 K	E	10140lm	RE5808S	
		CASAMBI	85 W	2700 K	E	10310lm	RE5807C	870,17 €
				3000 K	E	10690lm	RE5808C	
				2200-5000 K tunable white	E	11220lm	RE5811C	
○	<b>450 weiß</b> 450 white	ON/OFF	82 W	2700 K	E	9790lm	RE5820	778,58 €
				3000 K	E	10140lm	RE5821	
		ON/OFF SENSOR	82 W	2700 K	E	9790lm	RE5820S	870,17 €
				3000 K	E	10140lm	RE5821S	
		DALI	85 W	2700 K	E	10310lm	RE5827	833,53 €
				3000 K	E	10690lm	RE5828	
				2200-5000 K tunable white	E	11220lm	RE5831	
		DALI SENSOR	82 W	2700 K	E	9790lm	RE5827S	925,13 €
				3000 K	E	10140lm	RE5828S	
		CASAMBI	85 W	2700 K	E	10310lm	RE5827C	870,17 €
				3000 K	E	10690lm	RE5828C	
				2200-5000 K tunable white	E	11220lm	RE5831C	
●	<b>1000 schwarz</b> 1000 black	ON/OFF	82 W	2700 K	E	9790lm	RE5200	778,58 €
				3000 K	E	10140lm	RE5201	
		ON/OFF SENSOR	82 W	2700 K	E	9790lm	RE5200S	870,17 €
				3000 K	E	10140lm	RE5201S	
		DALI	85 W	2700 K	E	10310lm	RE5207	833,53 €
				3000 K	E	10690lm	RE5208	
				2200-5000 K tunable white	E	11220lm	RE5211	
		DALI SENSOR	82 W	2700 K	E	9790lm	RE5207S	925,13 €
				3000 K	E	10140lm	RE5208S	
		CASAMBI	85 W	2700 K	E	10310lm	RE5207C	870,17 €
				3000 K	E	10690lm	RE5208C	
				2200-5000 K tunable white	E	11220lm	RE5211C	
○	<b>1000 weiß</b> 1000 white	ON/OFF	82 W	2700 K	E	9790lm	RE5220	778,58 €
				3000 K	E	10140lm	RE5221	
		ON/OFF SENSOR	82 W	2700 K	E	9790lm	RE5220S	870,17 €
				3000 K	E	10140lm	RE5221S	
		DALI	85 W	2700 K	E	10310lm	RE5227	833,53 €
				3000 K	E	10690lm	RE5228	
				2200-5000 K tunable white	E	11220lm	RE5231	
		DALI SENSOR	82 W	2700 K	E	9790lm	RE5227S	925,13 €
				3000 K	E	10140lm	RE5228S	
		CASAMBI	85 W	2700 K	E	10310lm	RE5227C	870,17 €
				3000 K	E	10690lm	RE5228C	
				2200-5000 K tunable white	E	11220lm	RE5231C	

 modular article  
 IP20 protection class  
 emergency light option  
 battery option  
 sensor option

 LED  
 dimmable  
 tunable white  
 CRI >90  
 SDCM 3



## REFLEX<sup>2</sup> Ceiling XL Reflektor

Abbildung figure	Beschreibung description	Art.-Nr. art.-no.	€ netto CH excl. VAT
	<b>Pyramidenstruktur weiß</b> pyramid structure white	RE3201	
	<b>Pyramidenstruktur silber</b> pyramid structure silver	RE3202	132,82 €
	<b>Pyramidenstruktur gold</b> pyramid structure gold	RE3203	
	<b>matt weiß</b> matte white	RE3204	

+

modular  
article

## REFLEX<sup>2</sup> Ceiling XL Reflektor Cascade

Abbildung figure	Beschreibung description	Art.-Nr. art.-no.	€ netto CH excl. VAT
	<b>Pyramidenstruktur weiß</b> pyramid structure white	RE3211	
	<b>Pyramidenstruktur silber</b> pyramid structure silver	RE3212	206,10 €
	<b>Pyramidenstruktur gold</b> pyramid structure gold	RE3213	
	<b>matt weiß</b> matte white	RE3214	

+

modular  
article

# REFLEX<sup>2</sup> Wall

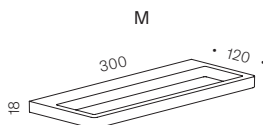

## REFLEX<sup>2</sup> Wall M

Abbildung figure	Beschreibung description	Regelung control	Leistung power	CCT	EEL EEC	Lumen lumen	Art.-Nr. art.-no.	€ netto CH excl. VAT
●	<b>schwarz</b> black	TRIAC	12 W	2700 K	E	1420 lm	RE4001	348,07 €
				3000 K	E	1470 lm	RE4003	
○	<b>weiß</b> white	TRIAC	12 W	2700 K	E	1420 lm	RE4002	
				3000 K	E	1470 lm	RE4004	

IP20  
protection  
class

LED      
dimmable CRI >90 SDCM 3

## Zubehör / Accessories

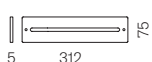
Abbildung figure	Beschreibung description	Art.-Nr. art.-no.	€ netto CH excl. VAT
	<b>Wandabdeckung M schwarz</b> wall cover M black	RE8520	32,06 €
	<b>Wandabdeckung M weiß</b> wall cover M white	RE8521	

# REFLEX<sup>2</sup> Table

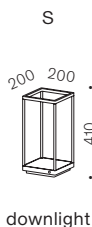

## REFLEX<sup>2</sup> Table

Abbildung figure	Beschreibung description	Regelung control	Leistung power	CCT	EEL EEC	Lumen lumen	Art.-Nr. art.-no.	€ netto CH excl. VAT
●	<b>schwarz</b> black	integr.	33 W	2200–3000 K dim2warm	E	3640 lm	RE3851	531,26 €
		CASAMBI	33 W	2200–3000 K dim2warm	E	3640 lm	RE3851C	659,49 €
○	<b>weiß</b> white	integr.	33 W	2200–3000 K dim2warm	E	3640 lm	RE3852	531,26 €
		CASAMBI	33 W	2200–3000 K dim2warm	E	3640 lm	RE3852C	659,49 €

IP20  
protection  
class

LED      
dimmable CRI >90 SDCM 3

# REFLEX<sup>2</sup> Floor

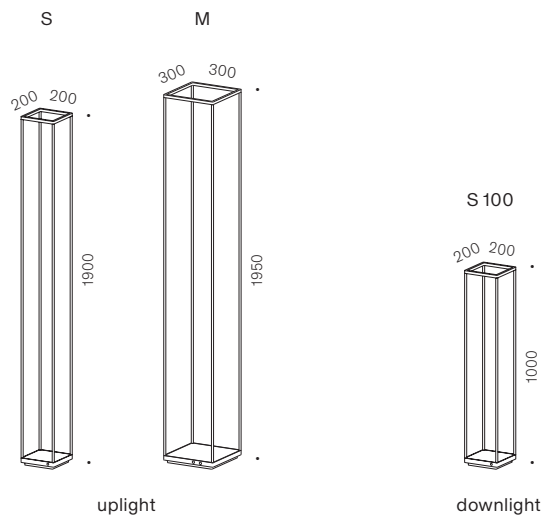

## REFLEX<sup>2</sup> Floor

Abbildung figure	Beschreibung description	Regelung control	Leistung power	CCT	EEK EEC	Lumen lumen	Art.-Nr. art.-no.	€ netto CH excl. VAT
●	<b>S schwarz</b> S black	integr.	33 W	2200-3000 K dim2warm	E	3640lm	RE3551	897,65 €
		CASAMBI	33 W	2200-3000 K dim2warm	E	3640lm	RE3551C	1.025,89 €
○	<b>S weiß</b> S white	integr.	33 W	2200-3000 K dim2warm	E	3640lm	RE3552	897,65 €
		CASAMBI	33 W	2200-3000 K dim2warm	E	3640lm	RE3552C	1.025,89 €
●	<b>M schwarz</b> M black	integr.	50 W	2200-5000 K tunable white	E	6580lm	RE3653	1.154,11 €
		CASAMBI	50 W	2200-5000 K tunable white	E	6580lm	RE3653C	1.273,20 €
○	<b>M weiß</b> M white	integr.	50 W	2200-5000 K tunable white	E	6580lm	RE3654	1.154,11 €
		CASAMBI	50 W	2200-5000 K tunable white	E	6580lm	RE3654C	1.273,20 €
●	<b>S100 schwarz</b> S100 black	integr.	33 W	2200-3000 K dim2warm	E	3640lm	RE3751	622,86 €
		CASAMBI	33 W	2200-3000 K dim2warm	E	3640lm	RE3751C	751,10 €
○	<b>S100 weiß</b> S100 white	integr.	33 W	2200-3000 K dim2warm	E	3640lm	RE3752	622,86 €
		CASAMBI	33 W	2200-3000 K dim2warm	E	3640lm	RE3752C	751,10 €

IP20  
protection  
class

LED      
dimnable dim2warm CRI >90 SDCM 3

# ROD Wall

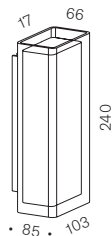

## ROD Wall new

Abbildung figure	Beschreibung description	Regelung control	Leistung power	CCT	EEK EEC	Lumen lumen	Art.-Nr. art.-no.	€ netto CH excl. VAT
○	opal	TRIAC	27 W	2700 K	E	3350 lm	RD1001	535,84 €
				3000 K <span style="color: #0070C0;">new</span>	E	3400 lm	RD1101	
		DALI	27 W	2700 K	E	3350 lm	RD1009	563,32 €
				3000 K <span style="color: #0070C0;">new</span>	E	3400 lm	RD1109	
		CASAMBI <span style="color: #0070C0;">new</span>	27 W	2700 K	E	3350 lm	RD1009C	654,92 €
				3000 K	E	3400 lm	RD1109C	
●	glanzverchromt chrome plated	TRIAC	27 W	2700 K	E	3350 lm	RD1002	535,84 €
				3000 K <span style="color: #0070C0;">new</span>	E	3400 lm	RD1102	
		DALI	27 W	2700 K	E	3350 lm	RD1010	563,32 €
				3000 K <span style="color: #0070C0;">new</span>	E	3400 lm	RD1110	
		CASAMBI <span style="color: #0070C0;">new</span>	27 W	2700 K	E	3350 lm	RD1010C	654,92 €
				3000 K	E	3400 lm	RD1110C	
●	gold eloxiert gold anodized	TRIAC	27 W	2700 K	E	3350 lm	RD1018	535,84 €
				3000 K <span style="color: #0070C0;">new</span>	E	3400 lm	RD1118	
		DALI	27 W	2700 K	E	3350 lm	RD1021	563,32 €
				3000 K <span style="color: #0070C0;">new</span>	E	3400 lm	RD1121	
		CASAMBI <span style="color: #0070C0;">new</span>	27 W	2700 K	E	3350 lm	RD1021C	654,92 €
				3000 K	E	3400 lm	RD1121C	

IP20    
 protection emergency  
 class light option individual

LED     
 dimmable CRI >90 SDCM 3

## Zubehör/Accessories

Abbildung figure	Beschreibung description	Art.-Nr. art.-no.	€ netto CH excl. VAT
	<b>Spiegeladapter Set ROD</b> mirror adapter set ROD	ZB1004	41,22 €

# SLICE<sup>2</sup> Furniture

Furniture

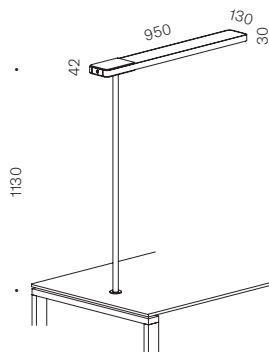

## SLICE<sup>2</sup> Furniture

Abbildung figure	Beschreibung description	Regelung control	Leistung power	CCT	EEK EEC	Lumen lumen	Art.-Nr. art.-no.	€ netto CH excl. VAT	
●	glanzverchromt chrome plated	integr.	85 W	3000 K	C	12570 lm	SL4003	1.515,93 €	
				4000 K	C	13340 lm	SL4004		
		Sensorik	85 W	3000 K	C	12570 lm	SL5003		1.708,28 €
				4000 K	C	13340 lm	SL5004		
●	schwarz black	integr.	85 W	3000 K	C	12570 lm	SL4103	1.419,75 €	
				4000 K	C	13340 lm	SL4104		
		Sensorik	85 W	3000 K	C	12570 lm	SL5103		1.612,10 €
				4000 K	C	13340 lm	SL5104		
○	weiß white	integr.	85 W	3000 K	C	12570 lm	SL4203	1.419,75 €	
				4000 K	C	13340 lm	SL4204		
		Sensorik	85 W	3000 K	C	12570 lm	SL5203		1.612,10 €
				4000 K	C	13340 lm	SL5204		
●	silber silver	integr.	85 W	3000 K	C	12570 lm	SL4303	1.419,75 €	
				4000 K	C	13340 lm	SL4304		
		Sensorik	85 W	3000 K	C	12570 lm	SL5303		1.612,10 €
				4000 K	C	13340 lm	SL5304		

IP20  
protection  
class

LED

UGR  
<11

CRI >80

dimmable

SDCM 3

# SLICE<sup>2</sup> Furniture

Furniture with adapter for  
USM Haller table systems

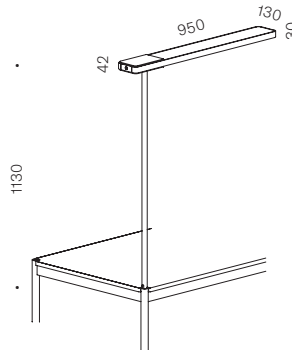

## SLICE<sup>2</sup> Furniture with adapter for USM Haller table systems

Abbildung figure	Beschreibung description	Regelung control	Leistung power	CCT	EEL EEC	Lumen lumen	Art.-Nr. art.-no.	€ netto CH excl. VAT	
●	<b>glanzverchromt</b> chrome plated	integr.	85 W	3000K	C	12570lm	SL4013	1.515,93 €	
				4000K	C	13340lm	SL4014		
		Sensorik	85 W	3000K	C	12570lm	SL5013		1.708,28 €
				4000K	C	13340lm	SL5014		
●	<b>schwarz</b> black	integr.	85 W	3000K	C	12570lm	SL4113	1.419,75 €	
				4000K	C	13340lm	SL4114		
		Sensorik	85 W	3000K	C	12570lm	SL5113		1.612,10 €
				4000K	C	13340lm	SL5114		
○	<b>weiß</b> white	integr.	85 W	3000K	C	12570lm	SL4213	1.419,75 €	
				4000K	C	13340lm	SL4214		
		Sensorik	85 W	3000K	C	12570lm	SL5213		1.612,10 €
				4000K	C	13340lm	SL5214		
●	<b>silber</b> silver	integr.	85 W	3000K	C	12570lm	SL4313	1.419,75 €	
				4000K	C	13340lm	SL4314		
		Sensorik	85 W	3000K	C	12570lm	SL5313		1.612,10 €
				4000K	C	13340lm	SL5314		

IP20  
protection  
class

LED UGR <11 CRI >80 dimmable SDCM 3

# SLICE<sup>2</sup> Floor

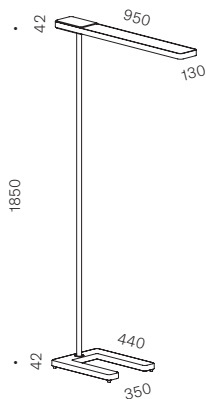

## SLICE<sup>2</sup> Floor

Abbildung figure	Beschreibung description	Regelung control	Leistung power	CCT	EEK EEC	Lumen lumen	Art.-Nr. art.-no.	€ netto CH excl. VAT
●	<b>glanzverchromt, Sockel silber</b> chrome plated, base silver	integr.	85 W	3000 K	C	12570 lm	SL2003	1.708,28 €
				4000 K	C	13340 lm	SL2004	
		Sensorik	85 W	3000 K	C	12570 lm	SL3003	
				4000 K	C	13340 lm	SL3004	
●	<b>schwarz</b> black	integr.	85 W	3000 K	C	12570 lm	SL2103	1.612,10 €
				4000 K	C	13340 lm	SL2104	
		Sensorik	85 W	3000 K	C	12570 lm	SL3103	
				4000 K	C	13340 lm	SL3104	
○	<b>weiß</b> white	integr.	85 W	3000 K	C	12570 lm	SL2203	1.612,10 €
				4000 K	C	13340 lm	SL2204	
		Sensorik	85 W	3000 K	C	12570 lm	SL3203	
				4000 K	C	13340 lm	SL3204	
●	<b>silber</b> silver	integr.	85 W	3000 K	C	12570 lm	SL2303	1.612,10 €
				4000 K	C	13340 lm	SL2304	
		Sensorik	85 W	3000 K	C	12570 lm	SL3303	
				4000 K	C	13340 lm	SL3304	

IP20  
protection  
class

LED

UGR  
<11

 CRI >80

 dimmable

 SDCM 3

# SLICE<sup>2</sup> PI Ceiling

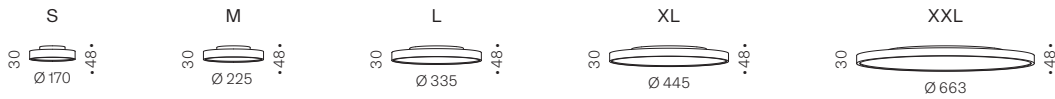

**SLICE<sup>2</sup> PI Ceiling ist auch für die Wandmontage geeignet - bitte achten Sie dabei auf mögliche Direktblendung. Eine spezielle SLICE<sup>2</sup> PI Wall-Variante finden Sie ab Seite 94 - dekorativ entblendet und asymmetrisch-abstrahlend.**  
 SLICE<sup>2</sup> PI Ceiling is also suitable for wall mounting - please be aware of potential direct glare. You will find a special SLICE<sup>2</sup> PI Wall variant from page 94 onwards - with decorative anti-glare treatment and asymmetrical light distribution.





## SLICE<sup>2</sup> PI Ceiling S new





Abbildung figure	Beschreibung description	Regelung control	Leistung power	CCT	EEL EEC	Lumen lumen	Art.-Nr. art.-no.	€ netto CH excl. VAT
	<b>DRIVER ENGINE</b> Ceiling S	TRIAC	13 W				DE011001	73,28 €
		DALI	10 W				DE011002	91,59 €
		CASAMBI	10 W				DE011002C	183,20 €
	<b>Gehäuse S schwarz</b> housing S black			2700 K	D	1180-1420 lm	PI1001	261,06 €
				3000 K	C	1230-1470 lm	PI1002	
				4000 K <span style="color: blue; font-weight: bold;">new</span>	C	1260-1510 lm	PI1003	
				2700 K	D	1180-1420 lm	PI1011	
				3000 K	C	1230-1470 lm	PI1012	
				4000 K <span style="color: blue; font-weight: bold;">new</span>	C	1260-1510 lm	PI1013	
	<b>Gehäuse S weiß</b> housing S white			2700 K	D	1180-1420 lm	PI1021	261,06 €
				3000 K	C	1230-1470 lm	PI1022	
				4000 K <span style="color: blue; font-weight: bold;">new</span>	C	1260-1510 lm	PI1023	
				2700 K	D	1180-1420 lm	PI1031	
				3000 K	C	1230-1470 lm	PI1032	
				4000 K <span style="color: blue; font-weight: bold;">new</span>	C	1260-1510 lm	PI1033	
	<b>Gehäuse S glanzverchromt</b> housing S chrome-plated			2700 K	D	1180-1420 lm	PI1041	297,69 €
				3000 K	C	1230-1470 lm	PI1042	
				4000 K <span style="color: blue; font-weight: bold;">new</span>	C	1260-1510 lm	PI1043	
				2700 K	D	1180-1420 lm	PI1051	
				3000 K	C	1230-1470 lm	PI1052	
				4000 K <span style="color: blue; font-weight: bold;">new</span>	C	1260-1510 lm	PI1053	
	<b>Gehäuse S crémant</b> housing S crémant			2700 K	D	1180-1420 lm	PI1061	279,37 €
				3000 K	C	1230-1470 lm	PI1062	
				4000 K <span style="color: blue; font-weight: bold;">new</span>	C	1260-1510 lm	PI1063	
				2700 K	D	1180-1420 lm	PI1071	
				3000 K	C	1230-1470 lm	PI1072	
				4000 K <span style="color: blue; font-weight: bold;">new</span>	C	1260-1510 lm	PI1073	

modular article  
 IP40 protection class  
 glass cover  
 chemically hardened

LED  
 dimmable  
 CRI > 95  
 SDCM 3



# SLICE<sup>2</sup> PI Ceiling M new

Abbildung figure	Beschreibung description	Regelung control	Leistung power	CCT	EEL EEC	Lumen lumen	Art.-Nr. art.-no.	€ netto CH excl. VAT
	<b>DRIVER ENGINE</b> Ceiling M	TRIAC	15 W				DE011011	87,01 €
		DALI	15 W				DE011012	123,66 €
		CASAMBI <span style="color: #0070C0;">new</span>	15 W				DE011012C	224,41 €
	<b>Gehäuse M schwarz</b> housing M black			2700 K	D	1900 lm	PI1101	357,23 €
				3000 K	C	1970 lm	PI1102	
				4000 K <span style="color: #0070C0;">new</span>	C	2020 lm	PI1103	
				2700 K	D	1900 lm	PI1111	
				3000 K	C	1970 lm	PI1112	
				4000 K <span style="color: #0070C0;">new</span>	C	2020 lm	PI1113	
	<b>Gehäuse M weiß</b> housing M white			2700 K	D	1900 lm	PI1121	357,23 €
				3000 K	C	1970 lm	PI1122	
				4000 K <span style="color: #0070C0;">new</span>	C	2020 lm	PI1123	
				2700 K	D	1900 lm	PI1131	
				3000 K	C	1970 lm	PI1132	
				4000 K <span style="color: #0070C0;">new</span>	C	2020 lm	PI1133	
	<b>Gehäuse M glanzverchromt</b> housing M chrome-plated			2700 K	D	1900 lm	PI1141	403,03 €
				3000 K	C	1970 lm	PI1142	
				4000 K <span style="color: #0070C0;">new</span>	C	2020 lm	PI1143	
				2700 K	D	1900 lm	PI1151	
				3000 K	C	1970 lm	PI1152	
				4000 K <span style="color: #0070C0;">new</span>	C	2020 lm	PI1153	
	<b>Gehäuse M crémant</b> housing M crémant			2700 K	D	1900 lm	PI1161	380,13 €
				3000 K	C	1970 lm	PI1162	
				4000 K <span style="color: #0070C0;">new</span>	C	2020 lm	PI1163	
				2700 K	D	1900 lm	PI1171	
				3000 K	C	1970 lm	PI1172	
				4000 K <span style="color: #0070C0;">new</span>	C	2020 lm	PI1173	

-  modular article
-  IP40 protection class
-  glass cover
-  chemically hardened



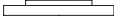
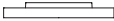

-  LED
-  dimmable
-  CRI > 95
-  SDCM 3







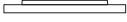

# SLICE<sup>2</sup> PI Ceiling L new

Abbildung figure	Beschreibung description	Regelung control	Leistung power	CCT	EK EEC	Lumen lumen	Art.-Nr. art.-no.	€ netto CH excl. VAT
	<b>DRIVER ENGINE</b> Ceiling L	TRIAC	22 W				DE011021	114,49 €
		DALI	22 W				DE011022	155,72 €
		CASAMBI	22 W				DE011022C	265,63 €
		SENSORIK	22 W				DE011022S	228,99 €
	<b>Gehäuse L schwarz</b> housing L black			2700 K	D	2840 lm	PI1201	485,46 €
				3000 K	C	2950 lm	PI1202	
				4000 K <span style="background-color: #0070C0; color: white; padding: 2px;">new</span>	C	3030 lm	PI1203	
				2700 K	D	2840 lm	PI1211	
				3000 K	C	2950 lm	PI1212	
				4000 K <span style="background-color: #0070C0; color: white; padding: 2px;">new</span>	C	3030 lm	PI1213	
	<b>Gehäuse L weiß</b> housing L white			2700 K	D	2840 lm	PI1221	485,46 €
				3000 K	C	2950 lm	PI1222	
				4000 K <span style="background-color: #0070C0; color: white; padding: 2px;">new</span>	C	3030 lm	PI1223	
				2700 K	D	2840 lm	PI1231	
				3000 K	C	2950 lm	PI1232	
				4000 K <span style="background-color: #0070C0; color: white; padding: 2px;">new</span>	C	3030 lm	PI1233	
	<b>Gehäuse L glanzverchromt</b> housing L chrome-plated			2700 K	D	2840 lm	PI1241	549,58 €
				3000 K	C	2950 lm	PI1242	
				4000 K <span style="background-color: #0070C0; color: white; padding: 2px;">new</span>	C	3030 lm	PI1243	
				2700 K	D	2840 lm	PI1251	
				3000 K	C	2950 lm	PI1252	
				4000 K <span style="background-color: #0070C0; color: white; padding: 2px;">new</span>	C	3030 lm	PI1253	
	<b>Gehäuse L crémant</b> housing L crémant			2700 K	D	2840 lm	PI1261	512,93 €
				3000 K	C	2950 lm	PI1262	
				4000 K <span style="background-color: #0070C0; color: white; padding: 2px;">new</span>	C	3030 lm	PI1263	
				2700 K	D	2840 lm	PI1271	
				3000 K	C	2950 lm	PI1272	
				4000 K <span style="background-color: #0070C0; color: white; padding: 2px;">new</span>	C	3030 lm	PI1273	







# SLICE<sup>2</sup> PI Ceiling XL new









Abbildung figure	Beschreibung description	Regelung control	Leistung power	CCT	EELCC	Lumen lumen	Art.-Nr. art.-no.	€ netto CH excl. VAT
	<b>DRIVER ENGINE</b> Ceiling XL	TRIAC	30W				DE011031	137,39 €
		DALI	30W				DE011032	178,62 €
		CASAMBI	30W				DE011032C	293,10 €
		SENSORIK	30W				DE011032S	251,89 €
	<b>Gehäuse XL schwarz</b> housing XL black			2700K	D	3790lm	PI1301	641,18 €
				3000K	C	3930lm	PI1302	
				4000K <span style="color: #0070C0;">new</span>	C	4040lm	PI1303	
				2700K	D	3790lm	PI1311	
				3000K	C	3930lm	PI1312	
				4000K <span style="color: #0070C0;">new</span>	C	4040lm	PI1313	
	<b>Gehäuse XL weiß</b> housing XL white			2700K	D	3790lm	PI1321	641,18 €
				3000K	C	3930lm	PI1322	
				4000K <span style="color: #0070C0;">new</span>	C	4040lm	PI1323	
				2700K	D	3790lm	PI1331	
				3000K	C	3930lm	PI1332	
				4000K <span style="color: #0070C0;">new</span>	C	4040lm	PI1333	
	<b>Gehäuse XL glanzverchromt</b> housing XL chrome-plated			2700K	D	3790lm	PI1341	732,77 €
				3000K	C	3930lm	PI1342	
				4000K <span style="color: #0070C0;">new</span>	C	4040lm	PI1343	
				2700K	D	3790lm	PI1351	
				3000K	C	3930lm	PI1352	
				4000K <span style="color: #0070C0;">new</span>	C	4040lm	PI1353	
	<b>Gehäuse XL crémant</b> housing XL crémant			2700K	D	3790lm	PI1361	686,97 €
				3000K	C	3930lm	PI1362	
				4000K <span style="color: #0070C0;">new</span>	C	4040lm	PI1363	
				2700K	D	3790lm	PI1371	
				3000K	C	3930lm	PI1372	
				4000K <span style="color: #0070C0;">new</span>	C	4040lm	PI1373	

-  modular article
-  IP40 protection class
-  through wiring
-  glass cover
-  chemically hardened
-  emergency light option
-  battery option
-  sensor option

- LED**
-  dimmable
-  CRI >95
-  SDCM 3

# SLICE<sup>2</sup> PI Ceiling XXL new

Abbildung figure	Beschreibung description	Regelung control	Leistung power	CCT	EEL EEC	Lumen lumen	Art.-Nr. art.-no.	€ netto CH excl. VAT
	<b>DRIVER ENGINE</b> Ceiling XXL	TRIAC	40 W				DE011041	137,39 €
		DALI	40 W				DE011042	178,62 €
		CASAMBI	40 W				DE011042C	293,10 €
		SENSORIK	40 W				DE011042S	251,89 €
	<b>Gehäuse XXL schwarz</b> housing XXL black			2700 K	D	5685 lm	PI1401	815,21 €
				3000 K	C	5895 lm	PI1402	
				4000 K	C	6060 lm	PI1403	
				2700 K	D	5685 lm	PI1411	
				3000 K	C	5895 lm	PI1412	
				4000 K	C	6060 lm	PI1413	
				2700 K	D	5685 lm	PI1421	
				3000 K	C	5895 lm	PI1422	
				4000 K	C	6060 lm	PI1423	
	<b>Gehäuse XXL weiß</b> housing XXL white			2700 K	D	5685 lm	PI1431	815,21 €
				3000 K	C	5895 lm	PI1432	
				4000 K	C	6060 lm	PI1433	
				2700 K	D	5685 lm	PI1461	
				3000 K	C	5895 lm	PI1462	
				4000 K	C	6060 lm	PI1463	
				2700 K	D	5685 lm	PI1471	
				3000 K	C	5895 lm	PI1472	
				4000 K	C	6060 lm	PI1473	
	<b>Gehäuse XXL crémant</b> housing XXL crémant			2700 K	D	5685 lm	PI1441	870,17 €
				3000 K	C	5895 lm	PI1442	
				4000 K	C	6060 lm	PI1443	
				2700 K	D	5685 lm	PI1471	
				3000 K	C	5895 lm	PI1472	
				4000 K	C	6060 lm	PI1473	
				2700 K	D	5685 lm	PI1471	
				3000 K	C	5895 lm	PI1472	
				4000 K	C	6060 lm	PI1473	

-  modular article
-  IP40 protection class
-  through wiring
-  glass cover
-  chemically hardened
-  emergency light option
-  battery option
-  sensor option

- LED
-  dimmable
-  CRI >95
-  SDCM 3

# SLICE<sup>2</sup> PI Suspension new

## Cable

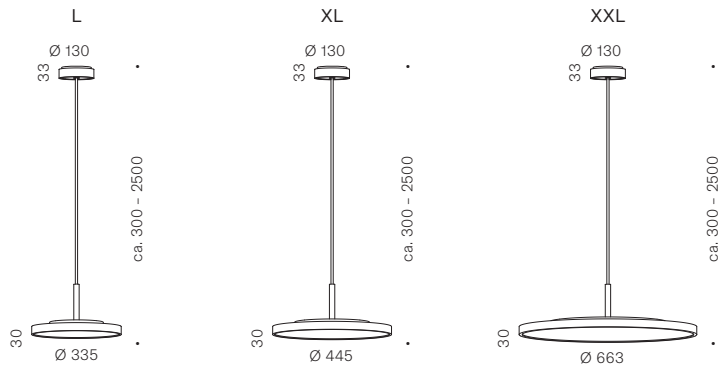

## Rope

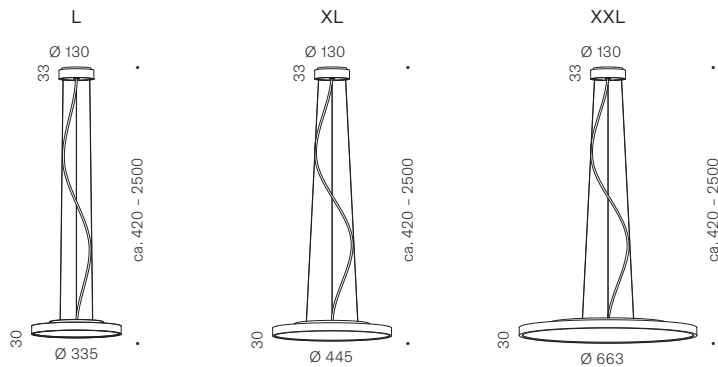

## Tube

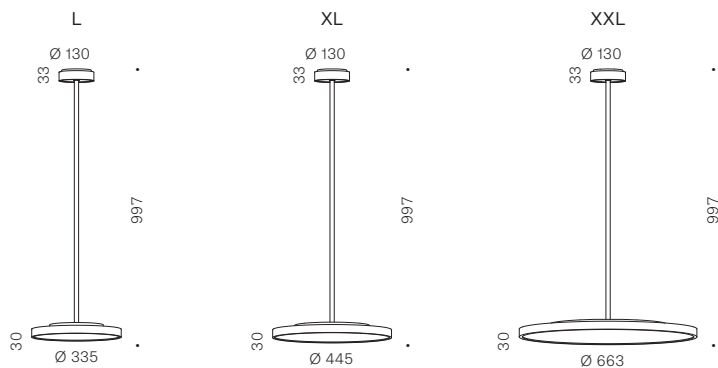

**Winkeladapter für Dachschrägen in weiß oder schwarz erhältlich – Montagehilfe für einfache Installation.**

**Der Winkel kann individuell angefertigt werden – Sonderfarben auf Anfrage.**

**Bestellungen (Art.-Nr.: weiß ZB1015, schwarz ZB1016) bitte in Abstimmung mit dem Vertrieb.**







Angle brackets for sloping roofs available in white or black – to assist with easy installation.







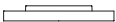

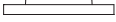
The brackets can be made to measure – special colours available on request.

Please coordinate orders (art.-no.: white ZB1015, black ZB1016) with the sales department.











# SLICE<sup>2</sup> PI Suspension Cable L new

Abbildung figure	Beschreibung description	Regelung control	Leistung power	CCT	EELCC	Lumen lumen	Art.-Nr. art.-no.	€ netto CH excl. VAT
	<b>DRIVER ENGINE</b> <b>Suspension Cable L schwarz</b> Suspension Cable L black	TRIAC	22 W				DE021111	270,21 €
		DALI	22 W				DE021211	311,42 €
		CASAMBI	22 W				DE021311	357,23 €
		SENSORIK	22 W				DE021411	384,70 €
	<b>DRIVER ENGINE</b> <b>Suspension Cable L weiß</b> Suspension Cable L white	TRIAC	22 W				DE021112	270,21 €
		DALI	22 W				DE021212	311,42 €
		CASAMBI	22 W				DE021312	357,23 €
		SENSORIK	22 W				DE021412	384,70 €
	<b>DRIVER ENGINE</b> <b>Suspension Cable L glanzverchromt</b> Suspension Cable L chrome	TRIAC	22 W				DE021113	316,01 €
		DALI	22 W				DE021213	357,23 €
		CASAMBI	22 W				DE021313	403,03 €
		SENSORIK	22 W				DE021413	430,51 €
	<b>DRIVER ENGINE</b> <b>Suspension Cable L crémant</b> Suspension Cable L crémant	TRIAC	22 W				DE021114	297,69 €
		DALI	22 W				DE021214	338,90 €
		CASAMBI	22 W				DE021314	384,70 €
		SENSORIK	22 W				DE021414	412,18 €
	<b>Gehäuse L schwarz</b> housing L black			2700 K	D	2840 lm	PI1211	
				3000 K	C	2950 lm	PI1212	
				4000 K <span style="background-color: #0070C0; color: white; padding: 2px;">new</span>	C	3030 lm	PI1213	485,46 €
	<b>Gehäuse L weiß</b> housing L white			2700 K	D	2840 lm	PI1231	
				3000 K	C	2950 lm	PI1232	
				4000 K <span style="background-color: #0070C0; color: white; padding: 2px;">new</span>	C	3030 lm	PI1233	
	<b>Gehäuse L glanzverchromt</b> housing L chrome-plated			2700 K	D	2840 lm	PI1251	
				3000 K	C	2950 lm	PI1252	549,58 €
				4000 K <span style="background-color: #0070C0; color: white; padding: 2px;">new</span>	C	3030 lm	PI1253	
	<b>Gehäuse L crémant</b> housing L crémant			2700 K	D	2840 lm	PI1271	
				3000 K	C	2950 lm	PI1272	512,93 €
				4000 K <span style="background-color: #0070C0; color: white; padding: 2px;">new</span>	C	3030 lm	PI1273	

-  modular article
-  IP40 protection class
-  through wiring
-  glass cover
-  chemically hardened
-  + length option
-  emergency light option
-  sensor option

-  LED
-  dimmable
-  CRI >95
-  SDCM 3







# SLICE<sup>2</sup> PI Suspension Cable XL new

Abbildung figure	Beschreibung description	Regelung control	Leistung power	CCT	EELCC EEC	Lumen lumen	Art.-Nr. art.-no.	€ netto CH excl. VAT
	<b>DRIVER ENGINE</b> <b>Suspension Cable XL schwarz</b> Suspension Cable XL black	TRIAC	30W				DE022111	311,42 €
		DALI	30W				DE022211	361,80 €
		CASAMBI	30W				DE022311	398,45 €
		SENSORIK	30W				DE022411	425,93 €
	<b>DRIVER ENGINE</b> <b>Suspension Cable XL weiß</b> Suspension Cable XL white	TRIAC	30W				DE022112	311,42 €
		DALI	30W				DE022212	361,80 €
		CASAMBI	30W				DE022312	398,45 €
		SENSORIK	30W				DE022412	425,93 €
	<b>DRIVER ENGINE</b> <b>Suspension Cable XL glanzverchromt</b> Suspension Cable XL chrome	TRIAC	30W				DE022113	375,55 €
		DALI	30W				DE022213	425,93 €
		CASAMBI	30W				DE022313	462,56 €
		SENSORIK	30W				DE022413	490,04 €
	<b>DRIVER ENGINE</b> <b>Suspension Cable XL crémant</b> Suspension Cable XL crémant	TRIAC	30W				DE022114	352,65 €
		DALI	30W				DE022214	403,03 €
		CASAMBI	30W				DE022314	439,66 €
		SENSORIK	30W				DE022414	467,14 €
	<b>Gehäuse XL schwarz</b> housing XL black			2700 K	D	3790 lm	PI1311	641,18 €
				3000 K	C	3930 lm	PI1312	
				4000 K <span style="color: #0070C0;">new</span>	C	4040 lm	PI1313	
	<b>Gehäuse XL weiß</b> housing XL white			2700 K	D	3790 lm	PI1331	732,77 €
				3000 K	C	3930 lm	PI1332	
				4000 K <span style="color: #0070C0;">new</span>	C	4040 lm	PI1333	
	<b>Gehäuse XL glanzverchromt</b> housing XL chrome-plated			2700 K	D	3790 lm	PI1351	686,97 €
				3000 K	C	3930 lm	PI1352	
				4000 K <span style="color: #0070C0;">new</span>	C	4040 lm	PI1353	
	<b>Gehäuse XL crémant</b> housing XL crémant			2700 K	D	3790 lm	PI1371	686,97 €
				3000 K	C	3930 lm	PI1372	
				4000 K <span style="color: #0070C0;">new</span>	C	4040 lm	PI1373	

-  modular article
-  IP40 protection class
-  through wiring
-  glass cover
-  chemically hardened
-  + length option
-  emergency light option
-  battery option
-  sensor option



- LED
-  dimmable
-  CRI >95
-  SDCM 3

# SLICE<sup>2</sup> PI Suspension Cable XXL new



Abbildung figure	Beschreibung description	Regelung control	Leistung power	CCT	EEK EEC	Lumen lumen	Art.-Nr. art.-no.	€ netto CH excl. VAT
	<b>DRIVER ENGINE</b> <b>Suspension Cable XXL schwarz</b> Suspension Cable XXL black	TRIAC	40W				DE023111	338,90 €
		DALI	40W				DE023211	389,28 €
		CASAMBI	40W				DE023311	425,93 €
		SENSORIK	40W				DE023411	453,41 €
	<b>DRIVER ENGINE</b> <b>Suspension Cable XXL weiß</b> Suspension Cable XXL white	TRIAC	40W				DE023112	338,90 €
		DALI	40W				DE023212	389,28 €
		CASAMBI	40W				DE023312	425,93 €
		SENSORIK	40W				DE023412	453,41 €
	<b>DRIVER ENGINE</b> <b>Suspension Cable XXL crémant</b> Suspension Cable XXL crémant	TRIAC	40W				DE023114	393,86 €
		DALI	40W				DE023214	444,24 €
		CASAMBI	40W				DE023314	480,89 €
		SENSORIK	40W				DE023414	508,37 €
	<b>Gehäuse XXL schwarz</b> housing XXL black			2700 K	D	5685 lm	PI1411	
				3000 K	C	5895 lm	PI1412	
				4000 K	C	6060 lm	PI1413	
	<b>Gehäuse XXL weiß</b> housing XXL white			2700 K	D	5685 lm	PI1431	
				3000 K	C	5895 lm	PI1432	
				4000 K	C	6060 lm	PI1433	
	<b>Gehäuse XXL crémant</b> housing XXL crémant			2700 K	D	5685 lm	PI1471	
				3000 K	C	5895 lm	PI1472	870,17 €
				4000 K	C	6060 lm	PI1473	









-  modular article
-  IP40 protection class
-  through wiring
-  glass cover
-  chemically hardened
-  + length option
-  emergency light option
-  battery option
-  sensor option

LED

-  dimmable
-  CRI >95
-  SDCM 3









# SLICE<sup>2</sup> PI Suspension Rope L new

Abbildung figure	Beschreibung description	Regelung control	Leistung power	CCT	EELCC	Lumen lumen	Art.-Nr. art.-no.	€ netto CH excl. VAT
	<b>DRIVER ENGINE</b> <b>Suspension Rope L schwarz</b> Suspension Rope L black	TRIAC	22 W				DE021121	261,06 €
		DALI	22 W				DE021221	302,27 €
		CASAMBI	22 W				DE021321	348,07 €
		SENSORIK	22 W				DE021421	375,55 €
	<b>DRIVER ENGINE</b> <b>Suspension Rope L weiß</b> Suspension Rope L white	TRIAC	22 W				DE021122	261,06 €
		DALI	22 W				DE021222	302,27 €
		CASAMBI	22 W				DE021322	348,07 €
		SENSORIK	22 W				DE021422	375,55 €
	<b>DRIVER ENGINE</b> <b>Suspension Rope L glanzverchromt</b> Suspension Rope L chrome	TRIAC	22 W				DE021123	306,85 €
		DALI	22 W				DE021223	348,07 €
		CASAMBI	22 W				DE021323	393,86 €
		SENSORIK	22 W				DE021423	421,34 €
	<b>DRIVER ENGINE</b> <b>Suspension Rope L crémant</b> Suspension Rope L crémant	TRIAC	22 W				DE021124	288,53 €
		DALI	22 W				DE021224	329,75 €
		CASAMBI	22 W				DE021324	375,55 €
		SENSORIK	22 W				DE021424	403,03 €
	<b>Gehäuse L schwarz</b> housing L black			2700 K	D	2840 lm	PI1211	485,46 €
				3000 K	C	2950 lm	PI1212	
				4000 K <span style="background-color: #0070C0; color: white; padding: 2px;">new</span>	C	3030 lm	PI1213	
	<b>Gehäuse L weiß</b> housing L white			2700 K	D	2840 lm	PI1231	485,46 €
				3000 K	C	2950 lm	PI1232	
				4000 K <span style="background-color: #0070C0; color: white; padding: 2px;">new</span>	C	3030 lm	PI1233	
	<b>Gehäuse L glanzverchromt</b> housing L chrome-plated			2700 K	D	2840 lm	PI1251	549,58 €
				3000 K	C	2950 lm	PI1252	
				4000 K <span style="background-color: #0070C0; color: white; padding: 2px;">new</span>	C	3030 lm	PI1253	
	<b>Gehäuse L crémant</b> housing L crémant			2700 K	D	2840 lm	PI1271	512,93 €
				3000 K	C	2950 lm	PI1272	
				4000 K <span style="background-color: #0070C0; color: white; padding: 2px;">new</span>	C	3030 lm	PI1273	

-  modular article
-  IP40 protection class
-  through wiring
-  glass cover
-  chemically hardened
-  + length option
-  emergency light option
-  sensor option

- LED
-  dimmable
-  CRI >95
-  SDCM 3

# SLICE<sup>2</sup> PI Suspension Rope XL new

Abbildung figure	Beschreibung description	Regelung control	Leistung power	CCT	EEK EEC	Lumen lumen	Art.-Nr. art.-no.	€ netto CH excl. VAT
	<b>DRIVER ENGINE</b> <b>Suspension Rope XL schwarz</b> Suspension Rope XL black	TRIAC	30W				DE022121	302,27 €
		DALI	30W				DE022221	352,65 €
		CASAMBI	30W				DE022321	389,28 €
		SENSORIK	30W				DE022421	416,76 €
	<b>DRIVER ENGINE</b> <b>Suspension Rope XL weiß</b> Suspension Rope XL white	TRIAC	30W				DE022122	302,27 €
		DALI	30W				DE022222	352,65 €
		CASAMBI	30W				DE022322	389,28 €
		SENSORIK	30W				DE022422	416,76 €
	<b>DRIVER ENGINE</b> <b>Suspension Rope XL glanzverchromt</b> Suspension Rope XL chrome	TRIAC	30W				DE022123	366,38 €
		DALI	30W				DE022223	416,76 €
		CASAMBI	30W				DE022323	453,41 €
		SENSORIK	30W				DE022423	480,89 €
	<b>DRIVER ENGINE</b> <b>Suspension Rope XL crémant</b> Suspension Rope XL crémant	TRIAC	30W				DE022124	352,65 €
		DALI	30W				DE022224	403,03 €
		CASAMBI	30W				DE022324	439,66 €
		SENSORIK	30W				DE022424	467,14 €
	<b>Gehäuse XL schwarz</b> housing XL black			2700K	D	3790lm	PI1311	641,18 €
				3000K	C	3930lm	PI1312	
				4000K <span style="background-color: #0070C0; color: white; padding: 2px;">new</span>	C	4040lm	PI1313	
	<b>Gehäuse XL weiß</b> housing XL white			2700K	D	3790lm	PI1331	732,77 €
				3000K	C	3930lm	PI1332	
				4000K <span style="background-color: #0070C0; color: white; padding: 2px;">new</span>	C	4040lm	PI1333	
	<b>Gehäuse XL glanzverchromt</b> housing XL chrome-plated			2700K	D	3790lm	PI1351	686,97 €
				3000K	C	3930lm	PI1352	
				4000K <span style="background-color: #0070C0; color: white; padding: 2px;">new</span>	C	4040lm	PI1353	
	<b>Gehäuse XL crémant</b> housing XL crémant			2700K	D	3790lm	PI1371	686,97 €
				3000K	C	3930lm	PI1372	
				4000K <span style="background-color: #0070C0; color: white; padding: 2px;">new</span>	C	4040lm	PI1373	

-  modular article
-  IP40 protection class
-  through wiring
-  glass cover
-  chemically hardened
-  + length option
-  emergency light option
-  battery option
-  sensor option

- LED
-  dimmable
-  CRI >95
-  SDCM 3







# SLICE<sup>2</sup> PI Suspension Rope XXL new

Abbildung figure	Beschreibung description	Regelung control	Leistung power	CCT	EELCC	Lumen lumen	Art.-Nr. art.-no.	€ netto CH excl. VAT
	<b>DRIVER ENGINE</b> <b>Suspension Rope XXL schwarz</b> Suspension Rope XXL black	TRIAC	40 W				DE023121	329,75 €
		DALI	40 W				DE023221	380,13 €
		CASAMBI	40 W				DE023321	416,76 €
		SENSORIK	40 W				DE023421	444,24 €
	<b>DRIVER ENGINE</b> <b>Suspension Rope XXL weiß</b> Suspension Rope XXL white	TRIAC	40 W				DE023122	329,75 €
		DALI	40 W				DE023222	380,13 €
		CASAMBI	40 W				DE023322	416,76 €
		SENSORIK	40 W				DE023422	444,24 €
	<b>DRIVER ENGINE</b> <b>Suspension Rope XXL crémant</b> Suspension Rope XXL crémant	TRIAC	40 W				DE023124	384,70 €
		DALI	40 W				DE023224	435,08 €
		CASAMBI	40 W				DE023324	471,72 €
		SENSORIK	40 W				DE023424	499,20 €
	<b>Gehäuse XXL schwarz</b> housing XXL black			2700 K	D	5685 lm	PI1411	815,21 €
				3000 K	C	5895 lm	PI1412	
				4000 K	C	6060 lm	PI1413	
	<b>Gehäuse XXL weiß</b> housing XXL white			2700 K	D	5685 lm	PI1431	870,17 €
				3000 K	C	5895 lm	PI1432	
				4000 K	C	6060 lm	PI1433	
	<b>Gehäuse XXL crémant</b> housing XXL crémant			2700 K	D	5685 lm	PI1471	870,17 €
				3000 K	C	5895 lm	PI1472	
				4000 K	C	6060 lm	PI1473	

- modular article
- IP40 protection class
- through wiring
- glass cover
- chemically hardened
- + length option
- emergency light option
- battery option
- sensor option

- LED
- dimmable
- CRI >95
- SDCM 3









# SLICE<sup>2</sup> PI Suspension Tube L new













Abbildung figure	Beschreibung description	Regelung control	Leistung power	CCT	EELCC	Lumen lumen	Art.-Nr. art.-no.	€ netto CH excl. VAT
	<b>DRIVER ENGINE</b> <b>Suspension Tube L schwarz</b> Suspension Tube L black	TRIAC	22 W				DE021131	242,73 €
		DALI	22 W				DE021231	283,95 €
		CASAMBI	22 W				DE021331	329,75 €
		SENSORIK	22 W				DE021431	375,55 €
	<b>DRIVER ENGINE</b> <b>Suspension Tube L weiß</b> Suspension Tube L white	TRIAC	22 W				DE021132	242,73 €
		DALI	22 W				DE021232	283,95 €
		CASAMBI	22 W				DE021332	329,75 €
		SENSORIK	22 W				DE021432	375,55 €
	<b>DRIVER ENGINE</b> <b>Suspension Tube L glanzverchromt</b> Suspension Tube L chrome	TRIAC	22 W				DE021133	288,53 €
		DALI	22 W				DE021233	329,75 €
		CASAMBI	22 W				DE021333	375,55 €
		SENSORIK	22 W				DE021433	421,34 €
	<b>DRIVER ENGINE</b> <b>Suspension Tube L crémant</b> Suspension Tube L crémant	TRIAC	22 W				DE021134	270,21 €
		DALI	22 W				DE021234	311,42 €
		CASAMBI	22 W				DE021334	357,23 €
		SENSORIK	22 W				DE021434	403,03 €
	<b>Gehäuse L schwarz</b> housing L black			2700 K	D	2840 lm	PI1211	485,46 €
				3000 K	C	2950 lm	PI1212	
				4000 K <span style="color: #0070C0;">new</span>	C	3030 lm	PI1213	
	<b>Gehäuse L weiß</b> housing L white			2700 K	D	2840 lm	PI1231	549,58 €
				3000 K	C	2950 lm	PI1232	
				4000 K <span style="color: #0070C0;">new</span>	C	3030 lm	PI1233	
	<b>Gehäuse L glanzverchromt</b> housing L chrome-plated			2700 K	D	2840 lm	PI1251	512,93 €
				3000 K	C	2950 lm	PI1252	
				4000 K <span style="color: #0070C0;">new</span>	C	3030 lm	PI1253	
	<b>Gehäuse L crémant</b> housing L crémant			2700 K	D	2840 lm	PI1271	512,93 €
				3000 K	C	2950 lm	PI1272	
				4000 K <span style="color: #0070C0;">new</span>	C	3030 lm	PI1273	

-  modular article
-  IP40 protection class
-  through wiring
-  glass cover
-  chemically hardened
-  tube cuttable
-  + length option
-  emergency light option
-  sensor option







- LED
-  dimmable
-  CRI >95
-  SDCM 3











# SLICE<sup>2</sup> PI Suspension Tube XL new

Abbildung figure	Beschreibung description	Regelung control	Leistung power	CCT	EELCC	Lumen lumen	Art.-Nr. art.-no.	€ netto CH excl. VAT
	<b>DRIVER ENGINE</b> <b>Suspension Tube XL schwarz</b> Suspension Tube XL black	TRIAC	30 W				DE022131	283,95 €
		DALI	30 W				DE022231	334,32 €
		CASAMBI	30 W				DE022331	370,97 €
		SENSORIK	30 W				DE022431	416,76 €
	<b>DRIVER ENGINE</b> <b>Suspension Tube XL weiß</b> Suspension Tube XL white	TRIAC	30 W				DE022132	283,95 €
		DALI	30 W				DE022232	334,32 €
		CASAMBI	30 W				DE022332	370,97 €
		SENSORIK	30 W				DE022432	416,76 €
	<b>DRIVER ENGINE</b> <b>Suspension Tube XL glanzverchromt</b> Suspension Tube XL chrome	TRIAC	30 W				DE022133	348,07 €
		DALI	30 W				DE022233	398,45 €
		CASAMBI	30 W				DE022333	435,08 €
		SENSORIK	30 W				DE022433	480,89 €
	<b>DRIVER ENGINE</b> <b>Suspension Tube XL crémant</b> Suspension Tube XL crémant	TRIAC	30 W				DE022134	334,32 €
		DALI	30 W				DE022234	384,70 €
		CASAMBI	30 W				DE022334	421,34 €
		SENSORIK	30 W				DE022434	467,14 €
	<b>Gehäuse XL schwarz</b> housing XL black			2700 K	D	3790 lm	PI1311	641,18 €
				3000 K	C	3930 lm	PI1312	
				4000 K <span style="color: #0070C0;">new</span>	C	4040 lm	PI1313	
	<b>Gehäuse XL weiß</b> housing XL white			2700 K	D	3790 lm	PI1331	732,77 €
				3000 K	C	3930 lm	PI1332	
				4000 K <span style="color: #0070C0;">new</span>	C	4040 lm	PI1333	
	<b>Gehäuse XL glanzverchromt</b> housing XL chrome-plated			2700 K	D	3790 lm	PI1351	686,97 €
				3000 K	C	3930 lm	PI1352	
				4000 K <span style="color: #0070C0;">new</span>	C	4040 lm	PI1353	
	<b>Gehäuse XL crémant</b> housing XL crémant			2700 K	D	3790 lm	PI1371	686,97 €
				3000 K	C	3930 lm	PI1372	
				4000 K <span style="color: #0070C0;">new</span>	C	4040 lm	PI1373	



 modular article	 IP40 protection class	 through wiring	 glass cover	 chemically hardened	 tube cuttable	 + length option	 emergency light option	 battery option	 sensor option	<b>LED</b>	 dimmable	 CRI >95	 SDCM 3
--	---	--	---	---	---	---	--	--	---	------------	--	---	--

# SLICE<sup>2</sup> PI Suspension Tube XXL new

Abbildung figure	Beschreibung description	Regelung control	Leistung power	CCT	EEK EEC	Lumen lumen	Art.-Nr. art.-no.	€ netto CH excl. VAT
	<b>DRIVER ENGINE</b> <b>Suspension Tube XXL schwarz</b> Suspension Tube XXL black	TRIAC	40W				DE023131	311,42 €
		DALI	40W				DE023231	361,80 €
		CASAMBI	40W				DE023331	398,45 €
		SENSORIK	40W				DE023431	425,93 €
	<b>DRIVER ENGINE</b> <b>Suspension Tube XXL weiß</b> Suspension Tube XXL white	TRIAC	40W				DE023132	311,42 €
		DALI	40W				DE023232	361,80 €
		CASAMBI	40W				DE023332	398,45 €
		SENSORIK	40W				DE023432	425,93 €
	<b>DRIVER ENGINE</b> <b>Suspension Tube XXL crémant</b> Suspension Tube XXL crémant	TRIAC	40W				DE023134	366,38 €
		DALI	40W				DE023234	416,76 €
		CASAMBI	40W				DE023334	471,72 €
		SENSORIK	40W				DE023434	480,89 €
	<b>Gehäuse XXL schwarz</b> housing XXL black			2700 K	D	5685 lm	PI1411	815,21 €
				3000 K	C	5895 lm	PI1412	
				4000 K	C	6060 lm	PI1413	
	<b>Gehäuse XXL weiß</b> housing XXL white			2700 K	D	5685 lm	PI1431	815,21 €
				3000 K	C	5895 lm	PI1432	
				4000 K	C	6060 lm	PI1433	
	<b>Gehäuse XXL crémant</b> housing XXL crémant			2700 K	D	5685 lm	PI1471	870,17 €
				3000 K	C	5895 lm	PI1472	
				4000 K	C	6060 lm	PI1473	

-  modular article
-  IP40 protection class
-  through wiring
-  glass cover
-  chemically hardened
-  tube cuttable
-  + length option
-  emergency light option
-  battery option
-  sensor option

LED

-  dimmable
-  CRI >95
-  SDCM 3

# SLICE<sup>2</sup> PI Wall new

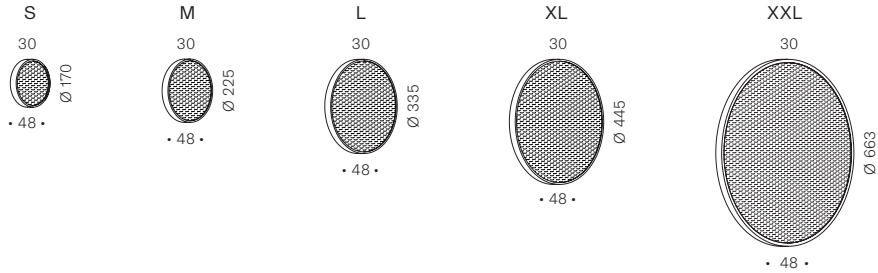

individual

Das asymmetrische Entblenderaster wird standardmäßig in weißer Pulverbeschichtung geliefert. Auf Anfrage kann die Vorderseite individuell farbig lackiert werden und ermöglicht so eine dekorative Gestaltung. Die Rückseite bleibt grundsätzlich weiß, um lichttechnisch optimale Eigenschaften sicherzustellen. Für eine individuelle Farbausführung kontaktieren Sie bitte den Vertrieb.





The asymmetrical anti-glare louvre is supplied as standard with a white powder-coated finish. On request, the front can be custom-painted in a colour of your choice, allowing for a decorative design. The rear remains white at all times to ensure optimal lighting performance. Please contact our sales department for custom colour options.



SLICE<sup>2</sup> PI Wall ist auch für die Deckenmontage geeignet- mit der asymmetrischen Abstrahlcharakteristik eines Wallwashers. Die rotationsymmetrisch nach unten abstrahlende Deckenleuchte finden Sie ab Seite 79.

SLICE<sup>2</sup> PI Wall is also suitable for ceiling mounting, allowing its asymmetrical beam pattern to be used as a wallwasher. You can find the rotationally symmetrical ceiling light with downward-facing light on page 79 onwards.









## SLICE<sup>2</sup> PI Wall S new

Abbildung figure	Beschreibung description	Regelung control	Leistung power	CCT	EEK EEC	Lumen lumen	Art.-Nr. art.-no.	€ netto CH excl. VAT
 <span style="background-color: #0070C0; color: white; padding: 2px;">new</span>	<b>DRIVER ENGINE</b> Wall S	TRIAC	13 W				DE021001	73,28 €
		DALI	10 W				DE021002	91,59 €
		CASAMBI	10 W				DE021002C	183,20 €
 <span style="background-color: #0070C0; color: white; padding: 2px;">new</span>	<b>Gehäuse S schwarz, asymmetrisches Entblenderaster</b> housing S black, asymmetrical anti-glare grid			2700K	D	1180-1420lm	PI2011	261,06 €
				3000K	C	1230-1470lm	PI2012	
				4000K	C	1260-1510lm	PI2013	
 <span style="background-color: #0070C0; color: white; padding: 2px;">new</span>	<b>Gehäuse S weiß, asymmetrisches Entblenderaster</b> housing S white, asymmetrical anti-glare grid			2700K	D	1180-1420lm	PI2031	297,69 €
				3000K	C	1230-1470lm	PI2032	
				4000K	C	1260-1510lm	PI2033	
 <span style="background-color: #0070C0; color: white; padding: 2px;">new</span>	<b>Gehäuse S glanzverchromt, asymmetrisches Entblenderaster</b> housing S chrome-plated, asymmetrical anti-glare grid			2700K	D	1180-1420lm	PI2051	279,37 €
				3000K	C	1230-1470lm	PI2052	
				4000K	C	1260-1510lm	PI2053	
 <span style="background-color: #0070C0; color: white; padding: 2px;">new</span>	<b>Gehäuse S crémant, asymmetrisches Entblenderaster</b> housing S crémant, asymmetrical anti-glare grid			2700K	D	1180-1420lm	PI2071	279,37 €
				3000K	C	1230-1470lm	PI2072	
				4000K	C	1260-1510lm	PI2073	

 modular article  
 IP40 protection class  
 glass cover  
 chemically hardened  
 individual









 LED  
 dimmable  
 CRI >95  
 SDCM 3

## SLICE<sup>2</sup> PI Wall M new

Abbildung figure	Beschreibung description	Regelung control	Leistung power	CCT	EEK EEC	Lumen lumen	Art.-Nr. art.-no.	€ netto CH excl. VAT
 <span style="color: #0070C0;">new</span>	<b>DRIVER ENGINE</b> Wall M	TRIAC	15 W				DE021011	87,01 €
		DALI	15 W				DE021012	123,66 €
		CASAMBI	15 W				DE021012C	224,41 €
  <span style="color: #0070C0;">new</span>	<b>Gehäuse M schwarz, asymmetrisches Entblenderaster</b> housing M black, asymmetrical anti-glare grid			2700 K	D	1900 lm	PI2111	357,23 €
				3000 K	C	1970 lm	PI2112	
				4000 K	C	2020 lm	PI2113	
  <span style="color: #0070C0;">new</span>	<b>Gehäuse M weiß, asymmetrisches Entblenderaster</b> housing M white, asymmetrical anti-glare grid			2700 K	D	1900 lm	PI2131	403,03 €
				3000 K	C	1970 lm	PI2132	
				4000 K	C	2020 lm	PI2133	
  <span style="color: #0070C0;">new</span>	<b>Gehäuse M glanzverchromt, asymmetrisches Entblenderaster</b> housing M chrome-plated, asymmetrical anti-glare grid			2700 K	D	1900 lm	PI2151	380,13 €
				3000 K	C	1970 lm	PI2152	
				4000 K	C	2020 lm	PI2153	
  <span style="color: #0070C0;">new</span>	<b>Gehäuse M crémant, asymmetrisches Entblenderaster</b> housing M crémant, asymmetrical anti-glare grid			2700 K	D	1900 lm	PI2171	380,13 €
				3000 K	C	1970 lm	PI2172	
				4000 K	C	2020 lm	PI2173	



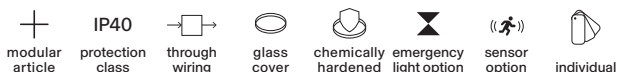

## SLICE<sup>2</sup> PI Wall L new

Abbildung figure	Beschreibung description	Regelung control	Leistung power	CCT	EEK EEC	Lumen lumen	Art.-Nr. art.-no.	€ netto CH excl. VAT
 <span style="color: #0070C0;">new</span>	<b>DRIVER ENGINE</b> Wall L	TRIAC	22 W				DE021021	114,49 €
		DALI	22 W				DE021022	155,72 €
		CASAMBI	22 W				DE021022C	265,63 €
		SENSORIK	22 W				DE021022S	228,99 €
  <span style="color: #0070C0;">new</span>	<b>Gehäuse L schwarz, asymmetrisches Entblenderaster</b> housing L black, asymmetrical anti-glare grid			2700 K	D	2840 lm	PI2211	485,46 €
				3000 K	C	2950 lm	PI2212	
				4000 K	C	3030 lm	PI2213	
  <span style="color: #0070C0;">new</span>	<b>Gehäuse L weiß, asymmetrisches Entblenderaster</b> housing L white, asymmetrical anti-glare grid			2700 K	D	2840 lm	PI2231	549,58 €
				3000 K	C	2950 lm	PI2232	
				4000 K	C	3030 lm	PI2233	
  <span style="color: #0070C0;">new</span>	<b>Gehäuse L glanzverchromt, asymmetrisches Entblenderaster</b> housing L chrome-plated, asymmetrical anti-glare grid			2700 K	D	2840 lm	PI2251	512,93 €
				3000 K	C	2950 lm	PI2252	
				4000 K	C	3030 lm	PI2253	
  <span style="color: #0070C0;">new</span>	<b>Gehäuse L crémant, asymmetrisches Entblenderaster</b> housing L crémant, asymmetrical anti-glare grid			2700 K	D	2840 lm	PI2271	512,93 €
				3000 K	C	2950 lm	PI2272	
				4000 K	C	3030 lm	PI2273	

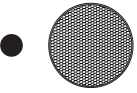
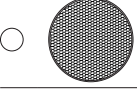

## SLICE<sup>2</sup> PI Wall XL new

Abbildung figure	Beschreibung description	Regelung control	Leistung power	CCT	EЕК EEC	Lumen lumen	Art.-Nr. art.-no.	€ netto CH excl. VAT
	<b>DRIVER ENGINE</b> Wall XL	TRIAC	30 W				DE021031	137,39 €
		DALI	30 W				DE021032	178,62 €
		CASAMBI	30 W				DE021032C	293,10 €
		SENSORIK	30 W				DE021032S	251,89 €
	<b>Gehäuse XL schwarz, asymmetrisches Entblenderaster</b> housing XL black, asymmetrical anti-glare grid			2700 K	D	3790 lm	PI2311	641,18 €
				3000 K	C	3930 lm	PI2312	
				4000 K	C	4040 lm	PI2313	
	<b>Gehäuse XL weiß, asymmetrisches Entblenderaster</b> housing XL white, asymmetrical anti-glare grid			2700 K	D	3790 lm	PI2331	641,18 €
				3000 K	C	3930 lm	PI2332	
				4000 K	C	4040 lm	PI2333	
	<b>Gehäuse XL glanzverchromt, asymmetrisches Entblenderaster</b> housing XL chrome-plated, asymmetrical anti-glare grid			2700 K	D	3790 lm	PI2351	732,77 €
				3000 K	C	3930 lm	PI2352	
				4000 K	C	4040 lm	PI2353	
	<b>Gehäuse XL crémant, asymmetrisches Entblenderaster</b> housing XL crémant, asymmetrical anti-glare grid			2700 K	D	3790 lm	PI2371	686,97 €
				3000 K	C	3930 lm	PI2372	
				4000 K	C	4040 lm	PI2373	

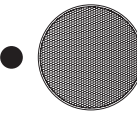
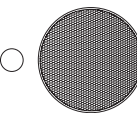
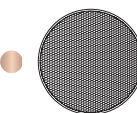

## SLICE<sup>2</sup> PI Wall XXL new

Abbildung figure	Beschreibung description	Regelung control	Leistung power	CCT	EЕК EEC	Lumen lumen	Art.-Nr. art.-no.	€ netto CH excl. VAT
	<b>DRIVER ENGINE</b> Wall XXL	TRIAC	40 W				DE021041	137,39 €
		DALI	40 W				DE021042	178,62 €
		CASAMBI	40 W				DE021042C	293,10 €
		SENSORIK	40 W				DE021042S	251,89 €
	<b>Gehäuse XXL schwarz, asymmetrisches Entblenderaster</b> housing XXL black, asymmetrical anti-glare grid			2700 K	D	5685 lm	PI2411	815,21 €
				3000 K	C	5895 lm	PI2412	
				4000 K	C	6060 lm	PI2413	
	<b>Gehäuse XXL weiß, asymmetrisches Entblenderaster</b> housing XXL white, asymmetrical anti-glare grid			2700 K	D	5685 lm	PI2431	815,21 €
				3000 K	C	5895 lm	PI2432	
				4000 K	C	6060 lm	PI2433	
	<b>Gehäuse XXL crémant, asymmetrisches Entblenderaster</b> housing XXL crémant, asymmetrical anti-glare grid			2700 K	D	5685 lm	PI2471	870,17 €
				3000 K	C	5895 lm	PI2472	
				4000 K	C	6060 lm	PI2473	



# SML Wall

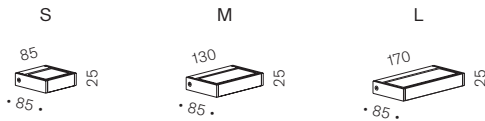



## SML Wall S



Abbildung figure	Beschreibung description	Fassung socket	Regelung control	Leistung power	EEK EEC	Art.-Nr. art.-no.	€ netto CH excl. VAT
●	<b>silber, satiniée/satiniée</b> silver, satiniée/satiniée	G9	TRIAC	max. 60 W	G	SM1172	265,63 €
	<b>silber, satiniée/Raster</b> silver, satiniée/raster	G9	TRIAC	max. 60 W	G	SM1199	
●	<b>glanzverchromt, satiniée/satiniée</b> chrome plated, satiniée/satiniée	G9	TRIAC	max. 60 W	G	SM3172	297,69 €
	<b>glanzverchromt, satiniée/Raster</b> chrome plated, satiniée/raster	G9	TRIAC	max. 60 W	G	SM3199	

IP20   
 protection class glass cover

## Zubehör/Accessories



Abbildung figure	Beschreibung description	Art.-Nr. art.-no.	€ netto CH excl. VAT
	<b>Spiegeladapter Set</b> mirror adapter set	ZB1001	41,22 €
 22 75	<b>Wandabdeckung S silber eloxiert</b> wall cover S silver anodized	SM1053	33,89 €
	<b>Wandabdeckung S glanzverchromt</b> wall cover S chrome-plated	SM3053	49,46 €

## SML Wall M



Abbildung figure	Beschreibung description	Fassung socket	Regelung control	Leistung power	E EK EEC	Art.-Nr. art.-no.	€ netto CH excl. VAT
	<b>silber, satinée/satinée</b> silver, satinée/satinée	R7s	TRIAC	max. 120 W	G	SM1173	283,95 €
	<b>silber, satinée/Raster</b> silver, satinée/raster	R7s	TRIAC	max. 120 W	G	SM1198	
	<b>glanzverchromt, satinée/satinée</b> chrome plated, satinée/satinée	R7s	TRIAC	max. 120 W	G	SM3173	320,59 €
	<b>glanzverchromt, satinée/Raster</b> chrome plated, satinée/raster	R7s	TRIAC	max. 120 W	G	SM3177	

IP20   
protection class glass cover

## Zubehör/Accessories



Abbildung figure	Beschreibung description	Art.-Nr. art.-no.	€ netto CH excl. VAT
	<b>Spiegeladapter Set</b> mirror adapter set	ZB1001	41,22 €
 22 120	<b>Wandabdeckung M silber eloxiert</b> wall cover M silver anodized	SM1054	35,72 €
	<b>Wandabdeckung M glanzverchromt</b> wall cover M chrome-plated	SM3054	54,96 €

## SML Wall L

Abbildung figure	Beschreibung description	Fassung socket	Regelung control	Leistung power	E EK EEC	Art.-Nr. art.-no.	€ netto CH excl. VAT
	<b>silber, satinée/satinée</b> silver, satinée/satinée	R7s	TRIAC	max. 160 W	G	SM1174	311,42 €
	<b>silber, satinée/Raster</b> silver, satinée/raster	R7s	TRIAC	max. 160 W	G	SM1175	
	<b>glanzverchromt, satinée/satinée</b> chrome plated, satinée/satinée	R7s	TRIAC	max. 160 W	G	SM3174	352,65 €
	<b>glanzverchromt, satinée/Raster</b> chrome plated, satinée/raster	R7s	TRIAC	max. 160 W	G	SM3176	

IP20   
protection class glass cover

## Zubehör/Accessories

Abbildung figure	Beschreibung description	Art.-Nr. art.-no.	€ netto CH excl. VAT
	<b>Spiegeladapter Set</b> mirror adapter set	ZB1001	41,22 €
 22 160	<b>Wandabdeckung L silber eloxiert</b> wall cover L silver anodized	SM1055	41,22 €
	<b>Wandabdeckung L glanzverchromt</b> wall cover L chrome-plated	SM3055	59,54 €

# SML<sup>2</sup> Wall

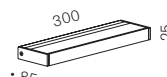
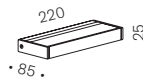
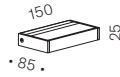



## SML<sup>2</sup> Wall 150

Abbildung figure	Beschreibung description	Regelung control	Leistung power	CCT	EEL EEC	Lumen lumen	Art.-Nr. art.-no.	€ netto CH excl. VAT	
●	<b>silber, satiniée/satiniée</b> silver, satiniée/satiniée	ON/OFF	10 W	2700 K	D	1420 lm	SM1325	380,13 €	
	3000 K			D	1450 lm	SM1227			
●	<b>silber, satiniée/Raster</b> silver, satiniée/raster	ON/OFF	10 W	2700 K	D	1420 lm	SM1326		
	3000 K			D	1450 lm	SM1228			
○	<b>weiß, satiniée/satiniée</b> white, satiniée/satiniée	ON/OFF	10 W	2700 K	D	1420 lm	SM1327		380,13 €
	3000 K			D	1450 lm	SM1229			
○	<b>weiß, satiniée/Raster</b> white, satiniée/raster	ON/OFF	10 W	2700 K	D	1420 lm	SM1328		
	3000 K			D	1450 lm	SM1230			
●	<b>schwarz, satiniée/satiniée</b> black, satiniée/satiniée	ON/OFF	10 W	2700 K	D	1420 lm	SM1329	380,13 €	
	3000 K			D	1450 lm	SM1231			
●	<b>schwarz, satiniée/Raster</b> black, satiniée/raster	ON/OFF	10 W	2700 K	D	1420 lm	SM1330		
	3000 K			D	1450 lm	SM1232			
●	<b>poliert, satiniée/satiniée</b> polished, satiniée/satiniée	ON/OFF	10 W	2700 K	D	1420 lm	SM1331		430,51 €
	3000 K			D	1450 lm	SM1233			
●	<b>poliert, satiniée/Raster</b> polished, satiniée/raster	ON/OFF	10 W	2700 K	D	1420 lm	SM1332		
	3000 K			D	1450 lm	SM1234			

IP20  
protection  
class

LED   
CRI >90

## Zubehör/Accessories

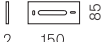
Abbildung figure	Beschreibung description	Art.-Nr. art.-no.	€ netto CH excl. VAT
	<b>Spiegeladapter Set</b> mirror adapter set	ZB1001	41,22 €
	<b>Wandadapter 150 silber</b> wall adapter 150 silver	SM8801	25,65 €
	<b>Wandadapter 150 weiß</b> wall adapter 150 white	SM8802	
	<b>Wandadapter 150 schwarz</b> wall adapter 150 black	SM8803	
	<b>Wandadapter 150 poliert</b> wall adapter 150 polished	SM8804	
	<b>Wandabdeckung 150 silber</b> wall cover 150 silver	SM4053	36,63 €
	<b>Wandabdeckung 150 weiß</b> wall cover 150 white	SM4056	
	<b>Wandabdeckung 150 schwarz</b> wall cover 150 black	SM4059	
	<b>Wandabdeckung 150 poliert</b> wall cover 150 polished	SM4062	

## SML<sup>2</sup> Wall 220

Abbildung figure	Beschreibung description	Regelung control	Leistung power	CCT	EEL EEC	Lumen lumen	Art.-Nr. art.-no.	€ netto CH excl. VAT
●	<b>silber, satinée/satinée</b> silver, satinée/satinée	TRIAC	15 W	2700 K	D	1960 lm	SM1333	476,30 €
	3000 K			D	2010 lm	SM1235		
●	<b>silber, satinée/Raster</b> silver, satinée/raster	TRIAC	15 W	2700 K	D	1960 lm	SM1334	
	3000 K			D	2010 lm	SM1236		
○	<b>weiß, satinée/satinée</b> white, satinée/satinée	TRIAC	15 W	2700 K	D	1960 lm	SM1335	476,30 €
	3000 K			D	2010 lm	SM1237		
○	<b>weiß, satinée/Raster</b> white, satinée/raster	TRIAC	15 W	2700 K	D	1960 lm	SM1336	
	3000 K			D	2010 lm	SM1238		
●	<b>schwarz, satinée/satinée</b> black, satinée/satinée	TRIAC	15 W	2700 K	D	1960 lm	SM1337	476,30 €
	3000 K			D	2010 lm	SM1239		
●	<b>schwarz, satinée/Raster</b> black, satinée/raster	TRIAC	15 W	2700 K	D	1960 lm	SM1338	
	3000 K			D	2010 lm	SM1240		
●	<b>poliert, satinée/satinée</b> polished, satinée/satinée	TRIAC	15 W	2700 K	D	1960 lm	SM1339	522,10 €
	3000 K			D	2010 lm	SM1241		
●	<b>poliert, satinée/Raster</b> polished, satinée/raster	TRIAC	15 W	2700 K	D	1960 lm	SM1340	
	3000 K			D	2010 lm	SM1242		

IP20

protection  
class

LED



dimmmable CRI >90

## Zubehör/Accessories

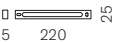
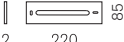
Abbildung figure	Beschreibung description	Art.-Nr. art.-no.	€ netto CH excl. VAT
	<b>Spiegeladapter Set</b> mirror adapter set	ZB1001	41,22 €
	<b>Wandadapter 220 silber</b> wall adapter 220 silver	SM8805	29,31 €
	<b>Wandadapter 220 weiß</b> wall adapter 220 white	SM8806	
	<b>Wandadapter 220 schwarz</b> wall adapter 220 black	SM8807	
	<b>Wandadapter 220 poliert</b> wall adapter 220 polished	SM8808	
	<b>Wandabdeckung 220 silber</b> wall cover 220 silver	SM4054	41,22 €
	<b>Wandabdeckung 220 weiß</b> wall cover 220 white	SM4057	
	<b>Wandabdeckung 220 schwarz</b> wall cover 220 black	SM4060	
	<b>Wandabdeckung 220 poliert</b> wall cover 220 polished	SM4052	

# SML<sup>2</sup> Wall 300

Abbildung figure	Beschreibung description	Regelung control	Leistung power	CCT	EEK EEC	Lumen lumen	Art.-Nr. art.-no.	€ netto CH excl. VAT
●	<b>silber, satinée/satinée</b> silver, satinée/satinée	TRIAC	20 W	2700 K	D	2670 lm	SM1341	577,06 €
				3000 K	D	2730 lm	SM1243	
		DALI	20 W	2700 K	D	2670 lm	SM1601	604,54 €
				3000 K	D	2730 lm	SM1602	
○	<b>silber, satinée/Raster</b> silver, satinée/raster	TRIAC	20 W	2700 K	D	2670 lm	SM1342	577,06 €
				3000 K	D	2730 lm	SM1244	
		DALI	20 W	2700 K	D	2670 lm	SM1603	604,54 €
				3000 K	D	2730 lm	SM1604	
○	<b>weiß, satinée/satinée</b> white, satinée/satinée	TRIAC	20 W	2700 K	D	2670 lm	SM1343	577,06 €
				3000 K	D	2730 lm	SM1245	
		DALI	20 W	2700 K	D	2670 lm	SM1605	604,54 €
				3000 K	D	2730 lm	SM1606	
○	<b>weiß, satinée/Raster</b> white, satinée/raster	TRIAC	20 W	2700 K	D	2670 lm	SM1344	577,06 €
				3000 K	D	2730 lm	SM1246	
		DALI	20 W	2700 K	D	2670 lm	SM1607	604,54 €
				3000 K	D	2730 lm	SM1608	
●	<b>schwarz, satinée/satinée</b> black, satinée/satinée	TRIAC	20 W	2700 K	D	2670 lm	SM1345	577,06 €
				3000 K	D	2730 lm	SM1247	
		DALI	20 W	2700 K	D	2670 lm	SM1609	604,54 €
				3000 K	D	2730 lm	SM1610	
●	<b>schwarz, satinée/Raster</b> black, satinée/raster	TRIAC	20 W	2700 K	D	2670 lm	SM1346	577,06 €
				3000 K	D	2730 lm	SM1248	
		DALI	20 W	2700 K	D	2670 lm	SM1611	604,54 €
				3000 K	D	2730 lm	SM1612	
●	<b>poliert, satinée/satinée</b> polished, satinée/satinée	TRIAC	20 W	2700 K	D	2670 lm	SM1347	622,86 €
				3000 K	D	2730 lm	SM1249	
		DALI	20 W	2700 K	D	2670 lm	SM1613	650,34 €
				3000 K	D	2730 lm	SM1614	
●	<b>poliert, satinée/Raster</b> polished, satinée/raster	TRIAC	20 W	2700 K	D	2670 lm	SM1348	622,86 €
				3000 K	D	2730 lm	SM1250	
		DALI	20 W	2700 K	D	2670 lm	SM1615	650,34 €
				3000 K	D	2730 lm	SM1616	

IP20

protection  
class

LED



dimmmable CRI >90

## Zubehör/Accessories

Abbildung figure	Beschreibung description	Art.-Nr. art.-no.	€ netto CH excl. VAT
	<b>Spiegeladapter Set</b> mirror adapter set	ZB1001	41,22 €
 5 300 25	<b>Wandadapter 300 silber</b> wall adapter 300 silver	SM8809	32,06 €
	<b>Wandadapter 300 weiß</b> wall adapter 300 white	SM8810	
	<b>Wandadapter 300 schwarz</b> wall adapter 300 black	SM8811	
	<b>Wandadapter 300 poliert</b> wall adapter 300 polished	SM8812	
 2 300 25	<b>Wandabdeckung 300 silber</b> wall cover 300 silver	SM4055	45,80 €
	<b>Wandabdeckung 300 weiß</b> wall cover 300 white	SM4058	
	<b>Wandabdeckung 300 schwarz</b> wall cover 300 black	SM4061	
	<b>Wandabdeckung 300 poliert</b> wall cover 300 polished	SM4048	

# SML<sup>2</sup> Wall

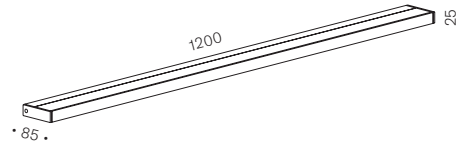
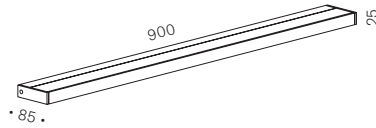
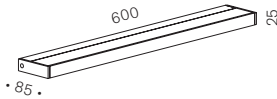

## SML<sup>2</sup> Wall 600

Abbildung figure	Beschreibung description	Regelung control	Leistung power	CCT	E EK EEC	Lumen lumen	Art.-Nr. art.-no.	€ netto CH excl. VAT	
●	<b>silber, satinée/satinée</b> silver, satinée/satinée	TRIAC	20 W	2700 K	D	2610 lm	SM1701	577,06 €	
				3000 K	D	2670 lm	SM1801		
				2700 K	D	2610 lm	SM1349		
		DALI	20 W	3000 K	D	2670 lm	SM1251		
				2700-5000 K tunable white	D	2820 lm	SM1501		622,86 €
				2700 K	D	2610 lm	SM1702		577,06 €
TRIAC	20 W	3000 K	D	2670 lm	SM1802				
		2700 K	D	2610 lm	SM1350				
		DALI	20 W	3000 K	D	2670 lm	SM1252		
2700-5000 K tunable white	D			2820 lm	SM1502	622,86 €			
●	<b>weiß, satinée/satinée</b> white, satinée/satinée			TRIAC	20 W	2700 K	D	2610 lm	
		3000 K	D			2670 lm	SM1803		
		2700 K	D			2610 lm	SM1351		
DALI	20 W	3000 K	D	2670 lm	SM1253				
		2700-5000 K tunable white	D	2820 lm	SM1503	622,86 €			
		○	<b>weiß, satinée/Raster</b> white, satinée/raster	TRIAC	20 W	2700 K	D	2610 lm	SM1704
3000 K	D					2670 lm	SM1804		
2700 K	D					2610 lm	SM1352		
DALI	20 W	3000 K	D	2670 lm	SM1254				
		2700-5000 K tunable white	D	2820 lm	SM1504	622,86 €			
		●	<b>schwarz, satinée/satinée</b> black, satinée/satinée	TRIAC	20 W	2700 K	D	2610 lm	SM1705
3000 K	D					2670 lm	SM1805		
2700 K	D					2610 lm	SM1353		
DALI	20 W	3000 K	D	2670 lm	SM1255				
		2700-5000 K tunable white	D	2820 lm	SM1505	622,86 €			
		○	<b>schwarz, satinée/Raster</b> black, satinée/raster	TRIAC	20 W	2700 K	D	2610 lm	SM1706
3000 K	D					2670 lm	SM1806		
2700 K	D					2610 lm	SM1354		
DALI	20 W	3000 K	D	2670 lm	SM1256				
		2700-5000 K tunable white	D	2820 lm	SM1506	622,86 €			
		●	<b>poliert, satinée/satinée</b> polished, satinée/satinée	TRIAC	20 W	2700 K	D	2610 lm	SM1707
3000 K	D					2670 lm	SM1807		
2700 K	D					2610 lm	SM1355		
DALI	20 W	3000 K	D	2670 lm	SM1257				
		2700-5000 K tunable white	D	2820 lm	SM1507	677,82 €			
		○	<b>poliert, satinée/Raster</b> polished, satinée/raster	TRIAC	20 W	2700 K	D	2610 lm	SM1708
3000 K	D					2670 lm	SM1808		
2700 K	D					2610 lm	SM1356		
DALI	20 W	3000 K	D	2670 lm	SM1258				
		2700-5000 K tunable white	D	2820 lm	SM1508	677,82 €			

IP30   
protection class through wiring

LED     
dimmable CRI > 90 tunable white

# SML<sup>2</sup> Wall 900

Abbildung figure	Beschreibung description	Regelung control	Leistung power	CCT	EEL EEC	Lumen lumen	Art.-Nr. art.-no.	€ netto CH excl. VAT	
●	<b>silber, satinée/satinée</b> silver, satinée/satinée	TRIAC	30 W	2700 K	D	3920lm	SM1709	632,01 €	
				3000 K	D	4010lm	SM1809		
				2700 K	D	3920lm	SM1357		
		DALI	30 W	3000 K	D	4010lm	SM1259		705,30 €
				2700-5000 K tunable white	D	4180lm	SM1511		
	<b>silber, satinée/Raster</b> silver, satinée/raster	TRIAC	30 W	2700 K	D	3920lm	SM1710	632,01 €	
				3000 K	D	4010lm	SM1810		
				2700 K	D	3920lm	SM1358		
		DALI	30 W	3000 K	D	4010lm	SM1260		705,30 €
				2700-5000 K tunable white	D	4180lm	SM1512		
○	<b>weiß, satinée/satinée</b> white, satinée/satinée	TRIAC	30 W	2700 K	D	3920lm	SM1711	632,01 €	
				3000 K	D	4010lm	SM1811		
				2700 K	D	3920lm	SM1359		
		DALI	30 W	3000 K	D	4010lm	SM1261		705,30 €
				2700-5000 K tunable white	D	4180lm	SM1513		
	<b>weiß, satinée/Raster</b> white, satinée/raster	TRIAC	30 W	2700 K	D	3920lm	SM1712	632,01 €	
				3000 K	D	4010lm	SM1812		
				2700 K	D	3920lm	SM1360		
		DALI	30 W	3000 K	D	4010lm	SM1262		705,30 €
				2700-5000 K tunable white	D	4180lm	SM1514		
●	<b>schwarz, satinée/satinée</b> black, satinée/satinée	TRIAC	30 W	2700 K	D	3920lm	SM1713	632,01 €	
				3000 K	D	4010lm	SM1813		
				2700 K	D	3920lm	SM1361		
		DALI	30 W	3000 K	D	4010lm	SM1263		705,30 €
				2700-5000 K tunable white	D	4180lm	SM1515		
	<b>schwarz, satinée/Raster</b> black, satinée/raster	TRIAC	30 W	2700 K	D	3920lm	SM1714	632,01 €	
				3000 K	D	4010lm	SM1814		
				2700 K	D	3920lm	SM1362		
		DALI	30 W	3000 K	D	4010lm	SM1264		705,30 €
				2700-5000 K tunable white	D	4180lm	SM1516		
●	<b>poliert, satinée/satinée</b> polished, satinée/satinée	TRIAC	30 W	2700 K	D	3920lm	SM1715	677,82 €	
				3000 K	D	4010lm	SM1815		
				2700 K	D	3920lm	SM1363		
		DALI	30 W	3000 K	D	4010lm	SM1265		751,10 €
				2700-5000 K tunable white	D	4180lm	SM1517		
	<b>poliert, satinée/Raster</b> polished, satinée/raster	TRIAC	30 W	2700 K	D	3920lm	SM1716	677,82 €	
				3000 K	D	4010lm	SM1816		
				2700 K	D	3920lm	SM1364		
		DALI	30 W	3000 K	D	4010lm	SM1266		751,10 €
				2700-5000 K tunable white	D	4180lm	SM1518		

IP30   
protection class through wiring

LED     
dimmable CRI > 90 tunable white

# SML<sup>2</sup> Wall 1200

Abbildung figure	Beschreibung description	Regelung control	Leistung power	CCT	EK EEC	Lumen lumen	Art.-Nr. art.-no.	€ netto CH excl. VAT
●	silber, satinée/satinée silver, satinée/satinée	TRIAC	40 W	2700 K	D	5230 lm	SM1717	723,62 €
				3000 K	D	5350 lm	SM1817	
				2700 K	D	5230 lm	SM1365	
		DALI	40 W	3000 K	D	5350 lm	SM1267	
				2700-5000 K tunable white	D	5480 lm	SM1521	
				2700 K	D	5230 lm	SM1718	
TRIAC	40 W	3000 K	D	5350 lm	SM1818			
		2700 K	D	5230 lm	SM1366			
		3000 K	D	5350 lm	SM1268			
DALI	40 W	2700-5000 K tunable white	D	5480 lm	SM1522			
		2700 K	D	5230 lm	SM1719	723,62 €		
		TRIAC	40 W	3000 K	D		5350 lm	SM1819
2700 K	D			5230 lm	SM1367			
3000 K	D			5350 lm	SM1269			
DALI	40 W	2700-5000 K tunable white	D	5480 lm	SM1523			
		2700 K	D	5230 lm	SM1720		723,62 €	
		TRIAC	40 W	3000 K	D	5350 lm		SM1820
2700 K	D			5230 lm	SM1368			
3000 K	D			5350 lm	SM1270			
DALI	40 W	2700-5000 K tunable white	D	5480 lm	SM1524			
		2700 K	D	5230 lm	SM1721	723,62 €		
		TRIAC	40 W	3000 K	D		5350 lm	SM1821
2700 K	D			5230 lm	SM1369			
3000 K	D			5350 lm	SM1271			
DALI	40 W	2700-5000 K tunable white	D	5480 lm	SM1525			
		2700 K	D	5230 lm	SM1722		723,62 €	
		TRIAC	40 W	3000 K	D	5350 lm		SM1822
2700 K	D			5230 lm	SM1370			
3000 K	D			5350 lm	SM1272			
DALI	40 W	2700-5000 K tunable white	D	5480 lm	SM1526			
		2700 K	D	5230 lm	SM1723	769,41 €		
		TRIAC	40 W	3000 K	D		5350 lm	SM1823
2700 K	D			5230 lm	SM1371			
3000 K	D			5350 lm	SM1273			
DALI	40 W	2700-5000 K tunable white	D	5480 lm	SM1527			
		2700 K	D	5230 lm	SM1724		769,41 €	
		TRIAC	40 W	3000 K	D	5350 lm		SM1824
2700 K	D			5230 lm	SM1372			
3000 K	D			5350 lm	SM1274			
DALI	40 W	2700-5000 K tunable white	D	5480 lm	SM1528			

IP30 → □ →  
protection class through wiring

LED     
dimmable CRI >90 tunable white

## Zubehör/Accessories

Abbildung figure	Beschreibung description	Art.-Nr. art.-no.	€ netto CH excl. VAT
	<b>Spiegeladapter Set</b> mirror adapter set	ZB1001	41,22 €

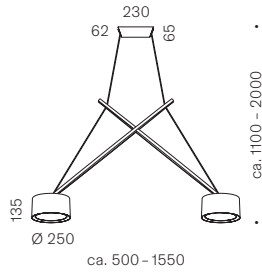

## TWIN

Abbildung figure	Beschreibung description	Leuchtmittel lamp	Regelung control	Leistung power	CCT	EEK EEC	Lumen lumen	Art.-Nr. art.-no.	€ netto CH excl. VAT
●	<b>schwarz, Acrylglas opal</b> black, acrylic glass opal	LED	TRIAC	23 W	2700 K	F	2240 lm	TW1103	1.373,95 €
					3000 K	E	2360 lm	TW1107	
		2 × G9	TRIAC	max. 120 W	2800 K	G	1960 lm	TW1003	1.021,30 €
●	<b>schwarz, Glas opal</b> black, glass opal	LED	TRIAC	23 W	2700 K	F	2240 lm	TW1303	1.612,10 €
					3000 K	E	2360 lm	TW1307	
		2 × G9	TRIAC	max. 120 W	2800 K	G	1960 lm	TW1203	1.231,97 €
●	<b>glanzverchromt, Acrylglas opal</b> chrome-plated, acrylic glass opal	LED	TRIAC	23 W	2700 K	F	2240 lm	TW1101	1.479,28 €
					3000 K	E	2360 lm	TW1105	
		2 × G9	TRIAC	max. 120 W	2800 K	G	1960 lm	TW1001	1.126,63 €
●	<b>glanzverchromt, Glas opal</b> chrome-plated, glass opal	LED	TRIAC	23 W	2700 K	F	2240 lm	TW1301	1.708,28 €
					3000 K	E	2360 lm	TW1305	
		2 × G9	TRIAC	max. 120 W	2800 K	G	1960 lm	TW1201	1.328,15 €

IP20  
protection  
class

 dimmable
  CRI >90
  SDCM 3

# ZOOM

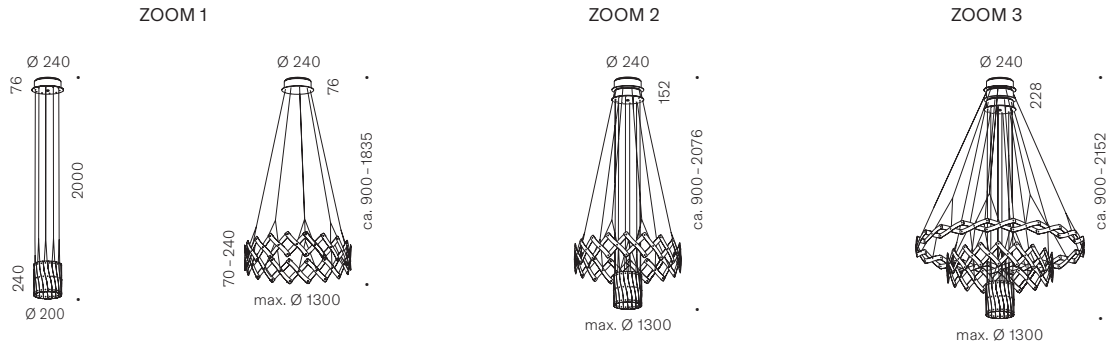

## ZOOM new

Abbildung figure	Beschreibung description	Leuchtmittel lamp	Regelung control	Leistung power	CCT	EEL EEC	Lumen lumen	Art.-Nr. art.-no.	€ netto CH excl. VAT	
●	<b>1 gebürstet</b> 1 brushed	LED	TRIAC	35 W	2700 K	F	2700lm	ZO3001	1364,79 €	
			DALI	35 W	2700 K	F	2700lm	ZO3011	1456,38 €	
			CASAMBI <span style="color: #0070C0;">new</span>	35 W	2700 K	F	2700lm	ZO3001C	1538,82 €	
	<b>2 gebürstet</b> 2 brushed	LED	20 × G4	TRIAC	max. 200 W	2700 K	G	2600lm	ZO1001	961,76 €
				DALI	70 W	2700 K	F	5400lm	ZO3002	2656,30 €
				CASAMBI <span style="color: #0070C0;">new</span>	70 W	2700 K	F	5400lm	ZO3002C	2839,49 €
	<b>3 gebürstet</b> 3 brushed	LED	40 × G4	TRIAC	max. 400 W	2700 K	G	5200lm	ZO1003	1831,93 €
				DALI	105 W	2700 K	F	8100lm	ZO3003	3938,66 €
				CASAMBI <span style="color: #0070C0;">new</span>	105 W	2700 K	F	8100lm	ZO3003C	4213,45 €
		60 × G4	TRIAC	max. 600 W	2700 K	G	7800lm	ZO1006	2656,30 €	

IP20  
protection  
class

↑  
+ length  
option

individual

dimmable

CRI >90

SDCM 3

## Zubehör/Accessories

Abbildung figure	Beschreibung description	Art.-Nr. art.-no.	€ netto CH excl. VAT
	<b>ZOOM Kristallglas Set (20 Stk.)</b> ZOOM Kristallglas Set (20 pcs.)	ZO1014	178,62 €



# Information



**Ein modularer Artikel ist eine Leuchte, die aus funktional getrennten Einzelkomponenten besteht und erst durch deren Kombination eine vollständige Leuchte bildet. Typische Bestandteile sind beispielsweise eine Lichteinheit (LED-Modul inkl. Vorschaltgerät) und ein optisches Element wie ein Glasschirm oder eine Abdeckung. Dieses modulare System ermöglicht eine flexible Konfiguration entsprechend technischer Anforderungen an Lichtverteilung oder Designvorgaben.**

A modular article is a luminaire that consists of functionally separate individual components and only forms a complete luminaire when they are combined. Typical components are, for example, a lighting unit (LED module incl. driver) and an optical element such as a glass shade or cover. This modular system enables flexible configuration according to technical requirements for light distribution or design specifications.



**Mit serien Individual haben Kunden die Möglichkeit, ihre Leuchten über das Standardsortiment hinaus in Farbe und Material individuell zu gestalten. Sonderausführungen mit anderen Lichtleistungen, Farbwiedergabeindizes, Oberflächen, Kabel- und Rohrlängen auf Anfrage. Für maßgeschneiderte Lösungen steht Ihnen unser Kundenservice gerne zur Verfügung.**

With serien Individual, customers have the option of customising the colour and material of their luminaires beyond the standard range.

Special versions with other light outputs, colour rendering indices, surfaces, cable and tube lengths on request. Our customer service team will be happy to help you with customised solutions.



**Unsere Produkte sind so konstruiert, dass beim Austausch von Lichtquellen nur eine qualifizierte Fachkraft sicherstellen kann, dass diese nicht verunreinigt und/oder beschädigt werden. Die Lebensdauer der Lichtquellen wird durch die Montageart mit Wärmeleitpads unmittelbar beeinflusst. Daher wird der nicht fachmännische Austausch von Lichtquellen und separaten Betriebsgeräten als nicht sinnvoll angesehen.**

Our products are designed in such a way that when light sources are replaced, only a qualified specialist can ensure that they are not contaminated and/or damaged. The service life of the light sources is directly affected by the mounting method with heat conducting pads. Therefore, the non-professional replacement of light sources and separate control gear is not considered appropriate.



**Eine Excel-Datei mit Artikelnummern und aktuellen Preisen stellen wir unseren Handelspartnern gerne zur Verfügung unter:**

**[www.serien.com/downloads](http://www.serien.com/downloads)**

We are happy to make the Excel file with article numbers and current prices available to our trade partners:

[www.serien.com/downloads](http://www.serien.com/downloads)



**Unter [www.serien.com/downloads](http://www.serien.com/downloads) finden Sie hilfreiche Informationen und die jeweils aktuellen technischen Daten:**













**Datenblätter, Kataloge, Preislisten, Lichttechnische Daten (EULUMDAT), 3D CAD-Daten, Konformitätserklärungen,**

**Retourenformular, FAQs, Montageanleitungen, Bohrschablonen und weitere Serviceanleitungen**







At [www.serien.com/downloads](http://www.serien.com/downloads) you will find helpful information and the latest technical data:

Data sheets, catalogues, price lists, lighting data (EULUMDAT), 3D CAD data, declarations of conformity, returns form, FAQs, assembly instructions, drilling templates and other service instructions.

# Luminaire features

 <p>IP20 protection class</p>	<p><b>Die Schutzart IP (International Protection Code) gibt an, wie gut ein elektrisches Gerät gegen das Eindringen von Fremdkörpern (z. B. Staub) und Wasser geschützt ist. Die Schutzart wird in der Norm DIN EN 60529 (VDE 0470-1) definiert.</b></p> <p>The IP (International Protection Code) rating indicates how well an electrical device is protected against the ingress of foreign bodies (e.g. dust) and water. The degree of protection is defined in the standard DIN EN 60529 (VDE 0470-1).</p>
 <p>glass lens</p>	<p><b>Die Abdeckung der LED erfolgt über eine hochwertige optische Echtglas-Sammellinse. Sie sorgt für eine präzise Lichtbündelung, minimiert Streuverluste und gewährleistet eine gleichmäßige Lichtverteilung bei gleichzeitig hoher Lichtausbeute. Durch die Verwendung von Echtglas bietet die Linse exzellente thermische und optische Eigenschaften sowie eine dauerhaft hohe Transparenz.</b></p> <p>The LED is covered by a high quality optical glass converging lens. It ensures precise light bundling, minimises scattering losses and guarantees uniform light distribution with high luminous efficacy. Thanks to the use of real glass, the lens offers excellent thermal and optical properties as well as permanently high transparency.</p>
 <p>chemically hardened</p>	<p><b>Chemisch gehärtetes Glas zeichnet sich durch eine hohe mechanische Festigkeit und Oberflächenhärte aus. Ein Ionenaustauschverfahren bewirkt eine deutlich erhöhte Beständigkeit gegen mechanische Beanspruchung, Temperaturschocks und Abrasion. Die veredelte Oberfläche sorgt zudem für eine optisch homogene Struktur mit hoher Lichttransmission und einem klaren, brillanten Erscheinungsbild.</b></p> <p>Chemically tempered glass is characterised by high mechanical strength and surface hardness. An ion exchange process significantly increases resistance to mechanical stress, temperature shocks and abrasion. The refined surface also ensures an optically homogeneous structure with high light transmission and a clear, brilliant appearance.</p>
 <p>cut 80 mm</p>	<p><b>Durchmesser des benötigten Deckenausschnitts für die Montage von Einbauleuchten in Hohldecken.</b></p> <p>Diameter of the cut-out required for the installation of recessed luminaires in hollow ceilings.</p>
 <p>tube cuttable</p>	<p><b>Das Pendelrohr der Leuchte ist in der Länge anpassbar und kann bei Bedarf durch den Kunden mit einer handelsüblichen Metallsäge individuell gekürzt werden. So lässt sich die Abpendelhöhe flexibel auf die jeweilige Einbausituation abstimmen.</b></p> <p>The pendant tube of the luminaire is adjustable in length and can be individually shortened by the customer using a standard metal saw if required. This allows the pendant height to be flexibly adapted to the respective installation situation.</p>
 <p>+ length option</p>	<p><b>Optional sind Abhängungen in Überlänge erhältlich. Für individuelle Anforderungen wenden Sie sich bitte an unseren Kundenservice.</b></p> <p>Extra-long suspensions are available as an option. For customised requirements, please contact our customer service.</p>
 <p>through wiring</p>	<p><b>Die Leuchten sind für eine Durchverdrahtung vorgesehen. Dadurch können mehrere Leuchten in Reihe geschaltet werden, ohne zusätzlichen Installationsaufwand. Dies gewährleistet eine schnelle, normgerechte und übersichtliche Elektroinstallation.</b></p> <p>The luminaires are designed for through-wiring. This means that several luminaires can be connected in a loop-through configuration without additional installation work. This ensures a quick, standardised and clear electrical installation.</p>
 <p>sensor option</p>	<p><b>Optional können die Leuchten mit intelligenten Sensoren ausgestattet werden, die Umgebungshelligkeit und/oder Anwesenheit von Personen erfassen. Dadurch wird die Beleuchtung bedarfsgerecht gesteuert, Energie eingespart und gleichzeitig der Komfort für die Nutzer erhöht.</b></p> <p>As an option, the luminaires can be equipped with intelligent sensors that detect the ambient brightness and/or the presence of people. This allows the lighting to be controlled as required, saving energy and increasing user comfort at the same time.</p>
 <p>battery option</p>	<p><b>Die Leuchten können optional mit einem integrierten Akku ausgestattet werden, um den Betrieb in Notbeleuchtungsanlagen sicherzustellen. Im Falle eines Netzausfalls schaltet die Leuchte automatisch in den Notbetrieb um und gewährleistet eine zuverlässige Grundbeleuchtung für die Dauer der vorgeschriebenen Überbrückungszeit.</b></p> <p>The luminaires can optionally be equipped with an integrated rechargeable battery to ensure operation in emergency lighting systems. In the event of a power failure, the luminaire automatically switches to emergency mode and ensures reliable basic lighting for the duration of the prescribed bridging time.</p>
 <p>emergency light option</p>	<p><b>Die DALI-Betriebsgeräte sind optional für den Einsatz in Notbeleuchtungsumgebungen geeignet und können problemlos in entsprechende Systeme eingebunden werden.</b></p> <p>The DALI control gear is optionally suitable for use in emergency lighting environments and can be easily integrated into corresponding systems.</p>
 <p>driver included</p>	<p><b>Alle Einbauleuchten sind standardmäßig mit einem passenden Betriebsgerät ausgestattet. Es entstehen keine zusätzlichen Kosten für externe Vorschaltgeräte, und die Leuchten können sofort nach der Installation in Betrieb genommen werden.</b></p> <p>All recessed luminaires are equipped with a suitable control gear as standard. There are no additional costs for external ballasts and the luminaires can be put into operation immediately after installation.</p>
 <p>lamp included</p>	<p><b>Die Leuchten werden werksseitig mit passendem Leuchtmittel geliefert und sind somit sofort betriebsbereit.</b></p> <p>The luminaires are supplied from the factory with a suitable light source and are therefore ready for immediate use.</p>

# Lighting technology

UGR <19	<p><b>Der UGR-Wert (Unified Glare Rating) gibt die Blendwirkung von Leuchten an. Je niedriger der Wert, desto geringer die psychologische Blendung. Für Bildschirmarbeitsplätze wird ein UGR <math>\leq 19</math> empfohlen. Unsere Leuchten sind so konzipiert, dass sie je nach Ausführung definierte UGR-Grenzwerte einhalten und hohen Sehkomfort bieten.</b></p> <p>The UGR value (Unified Glare Rating) indicates the glare effect of luminaires. The lower the value, the lower the psychological glare. A UGR <math>\leq 19</math> is recommended for VDU workstations. Our luminaires are designed to comply with defined UGR limit values and offer a high level of visual comfort, depending on the version.</p>
 dimmable	<p><b>Diese Leuchten sind dimmbar und erlauben eine flexible Anpassung der Lichtintensität. Je nach Modell werden unterschiedliche Dimmtechnologien unterstützt: Phasenabschnitt (TRIAC), DALI oder CASAMBI (Bluetooth). Für detaillierte Kompatibilitäts- und Steuerungs-Informationen wenden Sie sich bitte an unseren Kundenservice.</b></p> <p>These luminaires are dimmable and allow flexible adjustment of the light intensity. Depending on the model, different dimming technologies are supported: Trailing edge (TRIAC), DALI or CASAMBI (Bluetooth). For detailed compatibility and control information, please contact our customer service.</p>
 Zhaga standard	<p><b>Der Zhaga-Standard definiert herstellerübergreifende Schnittstellen für LED-Module, Treiber, Sensoren und Konnektoren. Er gewährleistet Interoperabilität, unterstützt modulare, zukunftssichere Leuchtendesigns und erleichtert Wartung sowie Austausch zur Steigerung der Systemlebensdauer und Nachhaltigkeit.</b></p> <p>The Zhaga standard defines manufacturer-independent interfaces for LED modules, drivers, sensors and connectors. It ensures interoperability, supports modular, future-proof luminaire designs and facilitates maintenance and replacement to increase system service life and sustainability.</p>
 tunable white	<p><b>Leuchten mit der Tunable White Funktionalität besitzen eine variable Farbtemperatursteuerung von warm- bis kaltweißem Licht.</b></p> <p>Luminaires with the tunable-white functionality have variable colour temperature control from warm to cool white light.</p>
 dim2warm	<p><b>Mit Dim2Warm wird eine Funktionalität der Leuchte bezeichnet, mit der das als angenehm empfundene Dimmverhalten von klassischen Glühfadenlampen imitiert wird. Beim Dimmen wird das Licht nicht nur dunkler, sondern ändert seine Lichtfarbe auch in den warmweißen Bereich.</b></p> <p>Dim2Warm refers to a luminaire functionality that imitates the pleasant dimming behavior of classic incandescent lamps. When dimmed, the light not only becomes darker, but also changes its colour to warm white tone.</p>
 CRI >97	<p><b>Der Farbwiedergabeindex wird zur Beurteilung der Qualität der Farbwiedergabe einer Lichtquelle herangezogen.</b></p> <p>The colour rendering index is used to assess the quality of the colour rendering of a light source.</p>
 SDCM 2	<p><b>Der SDCM-Wert (Standard Deviation of Color Matching) beschreibt die Farbkonsistenz von LEDs. Je niedriger der Wert, desto gleichmäßiger erscheint das Licht mehrerer Leuchten derselben Serie. Ein SDCM <math>\leq 3</math> steht für eine sehr hohe Farbtreue ohne sichtbare Farbunterschiede – ideal für anspruchsvolle Anwendungen mit hohem ästhetischem Anspruch.</b></p> <p>The SDCM value (Standard Deviation of Color Matching) describes the colour consistency of LEDs. The lower the value, the more uniform the light of several luminaires in the same series appears. An SDCM <math>\leq 3</math> stands for very high colour fidelity without visible colour differences - ideal for demanding applications with high aesthetic requirements.</p>
TRIAC	<p><b>Diese Leuchten sind mit einem handelsüblichen Phasenabschnittsdimmer regelbar – sie können sowohl ein- und ausgeschaltet als auch in der Helligkeit stufenlos geregelt werden. Dafür ist eine 3-adrige Standard-Netzzuleitung ausreichend.</b></p> <p>Luminaires with this feature can be controlled with a standard phase cut dimmer – it can be switched on and off and continuously dimmed. A 3-wire standard mains cable is sufficient.</p>
DALI	<p><b>5-adrige Netzzuleitung bei Regelung über DALI oder 0/1–10 V erforderlich.</b></p> <p>5-core mains cable required for control via DALI or 0/1-10 V.</p>
CASAMBI	<p><b>Die Leuchten können optional mit einem CASAMBI-Modul ausgestattet werden und lassen sich dadurch komfortabel per Smartphone, Tablet oder Wandschalter über Bluetooth steuern. CASAMBI ermöglicht eine smarte und kabellose Lichtsteuerung ohne zusätzliche Steuerleitungen oder aufwendige Installation. Weiterführende Informationen unter <a href="http://www.casambi.com">www.casambi.com</a>.</b></p> <p>The luminaires can be optionally equipped with a CASAMBI module and can therefore be conveniently controlled via smartphone, tablet or wall switch using Bluetooth. CASAMBI enables smart and wireless lighting control without additional control cables or complex installation. Further information can be found at <a href="http://www.casambi.com">www.casambi.com</a>.</p>
CCT	<p><b>LED-Leuchten mit einer Farbtemperatur von 2700 K liefern wir kurzfristig.</b></p> <p><b>LED-Leuchten mit einer Farbtemperatur von 3000 K und höher haben in der Regel längere Lieferzeiten.</b></p> <p>We supply LED luminaires with a colour temperature of 2700 K at short notice. LED luminaires with a color temperature of 3000 K and higher usually have longer delivery times.</p>
Lumen	<p><b>Die Angaben zu Lichtstrom (Lumen) sind Nominalwerte, das heißt reine Modul-Lichtstromwerte. Der Lichtstrom gibt an, wie viel Licht nach allen Seiten abstrahlt.</b></p> <p>The luminous flux (lumen) specifications are nominal values, i.e. pure module luminous flux values. The luminous flux indicates how much light is emitted in all directions.</p>

# Service

**Bei Fragen zu unseren Produkten, deren Lieferbedingungen und Verfügbarkeiten kontaktieren Sie bitte unser Serviceteam.**

For questions about our products, their delivery conditions and availabilities, please contact our customer service any time.

+49 6106 6909 0  
serien@serien.com  
www.serien.com

## Business Contacts

### Deutschland N/O

---

Dzenan Ganibegovic  
PLZ 0, 1 - 39, 48 - 49, 57 - 65, 99

serien Raumleuchten GmbH  
Hainhäuser Straße 3-7  
63110 Rodgau  
Germany

E dzenan.ganibegovic@serien.com  
M +49 151 5122 1212  
T +49 6106 6909 248

---

### Deutschland S/W

---

Helmuth Grischy  
PLZ 40 - 47, 50 - 56, 66 - 98

serien Raumleuchten GmbH  
Hainhäuser Straße 3-7  
63110 Rodgau  
Germany

E helmuth.grischy@serien.com  
M +49 151 5092 8656  
T +49 6106 6909 252

---

### Switzerland

---

wirzpartner GmbH  
für Leuchten und Licht

Im oberen Boden 142  
8049 Zürich  
Schweiz

E info@wirzpartner.ch  
M +41 79 290 30 08  
T +41 55 260 19 60

---

### Austria

---

Peter Salat

serien Raumleuchten GmbH  
Hainhäuser Straße 3-7  
63110 Rodgau  
Germany

E peter.salat@serien.com  
M +49 179 496 57 43  
T +49 6106 6909 232

---

### Brazil

---

FAS iluminação

Alameda Gabriel Monteiro da Silva,  
n° 413 Jardim America  
00.817.414/0001-08 - São Paulo  
Brazil

E atendimento@fasiluminacao.com.br  
T +55 11 30861661  
M +55 11 94713-9743

---

### Italy

---

Farelaluce  
Ulrich Jetzt

Hainhäuser Straße 3-7  
63110 Rodgau  
Germany

E ulrich@farelaluca.it  
T +39 353 4804731

---

### Netherlands

---

Trampoluce  
Paul van der Vegt

E info@trampoluce.nl  
M +31 620 601 661  
T +31 24 37 30 628

---

### Portugal

---

In-One  
Manuela Peres

EN 125  
8100-O68 Benfarras/Boliqueime  
Portugal

E manuelaperes@in-one.pt  
T +35 1938460199

---

### Worldwide

---

We are distributing worldwide.

Please contact our customer service for more information:

E serien@serien.com  
T +49 6106 6909 0

---

# Awards

## ANNEX

2013	German Design Award, Nominierung
2012	Design Plus
2011	Internationaler Designpreis Baden-Württemberg, Focus Silber

## APP

2017	German Design Award, Special Mention
2016	Design Plus
2016	Iconic Award, Interior Innovation, Winner

## CAVITY

2019	German Design Award, Winner
2019	Nominierung Leuchte des Jahres

## CURLING

2020	Innovationspreis Architektur+Technik
2018	German Design Award, Winner
2016	Internationaler Designpreis Baden-Württemberg, Focus Silber
2016	Iconic Award, Interior Innovation, Best of Best

## CRIB

2019	German Design Award, Winner
------	-----------------------------

## ELANE

2012	Deutscher Designer Club, Gute Gestaltung, Bronze
------	--

## JOB

2011	Designpreis der Bundesrepublik Deutschland, Nominierung
2010	Deutscher Designer Club, Gute Gestaltung, Silber
2009	The Israel Museum, Collection

## JONES

1999	Red Dot Design Award
------	----------------------

## LID

2018	Iconic Award, Innovative Interior, Best of Best
------	---

## ONE EIGHTY

2011	Designpreis der Bundesrepublik Deutschland, Nominierung
2010	Red Dot Design Award, Winner

## PROPELLER

2009	Designpreis der Bundesrepublik Deutschland, Nominierung
2009	The Israel Museum, Collection
2008	Red Dot Design Award, Winner

## REEF

2006	Designpreis der Bundesrepublik Deutschland, Nominierung
2004	Red Dot Design Award, Winner
2004	Design Plus
2004	Designpreis der Bundesrepublik Deutschland, Nominierung
2003	Internationaler Designpreis Baden-Württemberg, Focus Silber

## ROD

2019	Iconic Award, Innovative Interior, Best of Best
------	---

## REFLEX<sup>2</sup>

2024	Internationaler Designpreis Baden-Württemberg, Gold
2022	Internationaler Designpreis Baden-Württemberg, Special Mention
2022	German Design Award, Winner (Floor)
2022	Iconic Award, Innovative Interior, Best of Best
2021	Stylepark Selected
2021	Internationaler Designpreis Baden-Württemberg, Special Mention
2020	Design Plus
2020	German Design Award, Winner (Ceiling)

## SEVENTY SEVEN

1991	iF Product Award
1991	Stedelijk Museum Amsterdam, Collection

## SLANT

2013	German Design Award, Nominierung
2012	Deutscher Designer Club, Gute Gestaltung, Silber

## SLICE

2015	German Design Award, Nominierung
------	----------------------------------

## SLICE<sup>2</sup> PI

2023	Internationaler Designpreis Baden-Württemberg, Focus Gold
------	---

## SML

2006	Designpreis der Bundesrepublik Deutschland, Nominierung
2004	Red Dot Design Award, Winner
2004	Designpreis der Bundesrepublik Deutschland
2003	Internationaler Designpreis Baden-Württemberg, Focus Silber

## SML<sup>2</sup>

2014	German Design Award, Nominierung
2013	Designpreis der Bundesrepublik Deutschland, Nominierung
2013	Red Dot Design Award, Winner

## SML T5

2004	Design Plus
2004	Designpreis der Bundesrepublik Deutschland
2004	iF Product Award, Winner
2003	Internationaler Designpreis Baden-Württemberg, Focus Silber

## TWIN

2015	German Design Award, Gold
2014	Design Plus

## ZOOM

2007	Designpreis der Bundesrepublik Deutschland, Nominierung
2004	Designpreis der Bundesrepublik Deutschland, Nominierung
2003	Red Dot Design Award, Winner
2003	Internationaler Designpreis Baden-Württemberg, Focus Gold

© 2026 serien Raumluchten GmbH

**Alle Rechte vorbehalten. Jede Verwertung außerhalb der Grenzen des Urheberrechtsgesetzes ist ohne Zustimmung des Herausgebers unzulässig. Keine Reproduktionen ohne vorherige schriftliche Zustimmung. Alle Marken sind registriert. Alle Produkte sind gesetzlich geschützt. Verstöße werden in vollem Umfang strafrechtlich verfolgt. Änderungen vorbehalten.**  
All rights reserved. Any use outside the limits of copyright law without the publisher's consent is prohibited. No reproduction may be made without prior written consent. All trademarks are registered. All products are protected by law. Violations will be prosecuted to the full extent of the law. Subject to change without notice.

serien Raumluchten GmbH | Hainhäuser Straße 3-7 | 63110 Rodgau | Germany | [www.serien.com](http://www.serien.com) | [serien@serien.com](mailto:serien@serien.com)

